

# PREFACE

Thank you very much for choosing AE2 series of general purpose inverter.

This manual provides guidance of using the inverter safely and carefully, containing introduction of installation, wiring, parameters list, routine maintenance, operating rules and cautions, etc.

In order to make good use of the inverter properly and safely, please read this manual thoroughly before using. It may lead to abnormal operation and failure, reduce using life, even damage the equipment and cause personal injury if you use it wrongly.

This manual is attachment together with the inverter. Please keep it well and it would be available to engineering and installation personnel, repairing and maintaining during the product functioning period. AE2 has the right to modify and ameliorate products, data and dimensions without notice, so this manual is updated and all the contents in this manual are subject to change without any notice.



**ELECTRIC TECHNOLOGIES CO.,LTD**

# Table of Contents

<b>1 INTRODUCTION</b> .....	5
1.1 Model explanation .....	5
1.2 Appearance description .....	5
1.3 Model of inverter.....	7
1.4 Specifications.....	8
<b>2 INSTALLATION GUIDELINES</b> .....	10
2.1 Environmental requirements .....	10
2.2 Disassembly and assembly of the panel.....	10
2.3 Disassembly and assembly of the cover board.....	11
2.4 Dimension of inverter.....	12
<b>3 WIRING PROCEDURE</b> .....	15
3.1 Precautions .....	15
3.2 Wiring of external components .....	15
3.3 Basic wiring .....	17
3.4 Terminal of main circuit .....	18
3.5 Terminal of Control circuit .....	19
<b>4 OPERATIONS OF INVERTER AND SIMPLE RUNNING</b> .....	21
4.1 Operation panel.....	21
4.2 Basic function of panel and methods of operation.....	22
4.3 List of state monitor parameter .....	25
4.4 Simple operation.....	26
<b>5 PARAMETERS LIST</b> .....	27
<b>6 DESCRIPTION OF SPECIFIC FUNCTIONS</b> .....	37
6.1 Basic operation parameter unit .....	37
6.2 Primary application of parameter unit.....	41
6.3 Analog I/O parameter unit .....	45
6.4 Digital O/I parameter unit .....	48
6.5 Auxiliary running parameter unit .....	51
6.6 Multi-speed running parameter unit .....	56
6.7 Advanced running parameter unit .....	58
6.8 Wobble freq. running parameter unit .....	61
6.9 PID control parameter unit .....	62
6.10 Communication function parameter units .....	65
6.11 Special function parameter unit .....	66
<b>7 FAULT DIAGNOSIS AND COUNTERMEASURES</b> .....	69
7.1 Protective functions and countermeasures.....	69
7.2 Fault record inquiry .....	70
7.3 Reset .....	70

---

<b>8 MAINTENANCE</b> .....	71
8.1 Daily Maintenance .....	71
8.2 Damageable parts maintenance .....	72
8.3 Storage.....	72
8.4 After sale services.....	72
<b>9 USAGE EXAMPLE</b> .....	73
9.1 Panel on-off control, Panel potentiometer setting frequency.....	73
9.2 External on-off control mode, external voltage setting frequency.....	73
9.3 Multi-speed running, external on-off control mode.....	74
9.4 Panel on-off control, Panel potentiometer setting frequency and linkage control with inverters .....	74
<b>Appendix I RS485 COMMUNICATION PROTOCOL</b> .....	76
<b>Appendix II OPTIONS</b> .....	84
1. Operation panel .....	84
2. Brake resistance .....	85

# ✧ PRECAUTIONS

In order to use the inverter properly and safely, please read this manual carefully before using. And you should follow the requirements of this manual to move, install, run, operate and repair the inverter.

## 1. Opening

- I Please check any damage that may have occurred during transportation.
- II Please check whether the nameplate data of inverter is in accordance with your order, if anything wrong, please contact supplier immediately.

Our product is manufactured, packed and transported in the strict quality system. But in case there is any error, please contact with our company or local agent, we will solve the problem as quickly as possible.

- Inverter's nameplate data

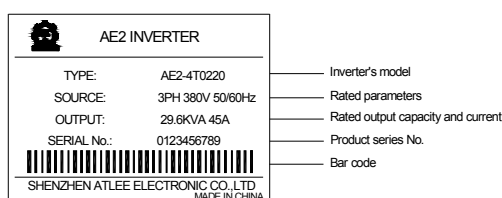

Fig-1 Nameplate

## 2. Safety regulations

There are four kinds of symbols being related with cautions as follows:



**Danger:** If user does not operate according to requirements, it will lead to death, grievous bodily harm or severe property loss.



**Warning:** If user does not operate according to requirements, it will lead to injury or damage of inverter.



This symbol will hint some useful information.



This symbol will hint some items that need to be noticed in operation.

## 2.1 Installing

- 2.1.1. Do not put the inverter on the combustible material.
- 2.1.2. AE2series inverter can't install in the explosive ambient.
- 2.1.3. Do not drop other material into the inverter.



It is forbidden to disassemble and refit the inverter.

## 2.2 Wiring

- 2.2.1. It must be operated by professional worker when wiring.
- 2.2.2. Please be sure to turn off the power supply at least 10 min before wiring.
- 2.2.3. Inverter and motor must be grounded correctly.
- 2.2.4. Be sure to wire or inspect the inverter after power-off at least 10 minutes.
- 2.2.5. Electron components are sensitive about static electricity, so do not drop other material in inverter or touch the main circuit.



It is forbidden to connect an AC power supply with the U, V and W output terminals directly

## 2.3 Maintenance



1. Do not touch the radiator after power-off at least 10 minutes.
2. The earth terminal of inverter must be connected to ground reliably.

## 3. Attention Notes:

- 3.1. Be sure to install the inverter in a well-ventilated ambient.
- 3.2. The temperature at variable-frequency will be higher than at line-frequency, which is normal phenomenon.
- 3.3. The ordinary motor cannot run in the low speed for a long time, so user should select the special motor for inverter or reduce the motor load under the low speed.
- 3.4. When the altitude is over 1000m, the inverter will be valid to decrease the rated current, and the rated current will decrease 10% when the attitude is increased 1500m.



Be sure not to connect the output terminals of inverter with the filter capacitors and other surge absorbers.

## 4 Dispose:

When you dispose inverter and its parts, please pay attention to:

**Capacitor:** The capacitors in inverter may explode when they are burned.

**Plastic:** Poisonous gas may be generated when the front panel is burned, please pay attention to the waste gas when the plastic parts are burned.

**Method:** Please dispose inverter as industry rubbish.

## 1. INTRODUCTION

### 1.1 Model explanation

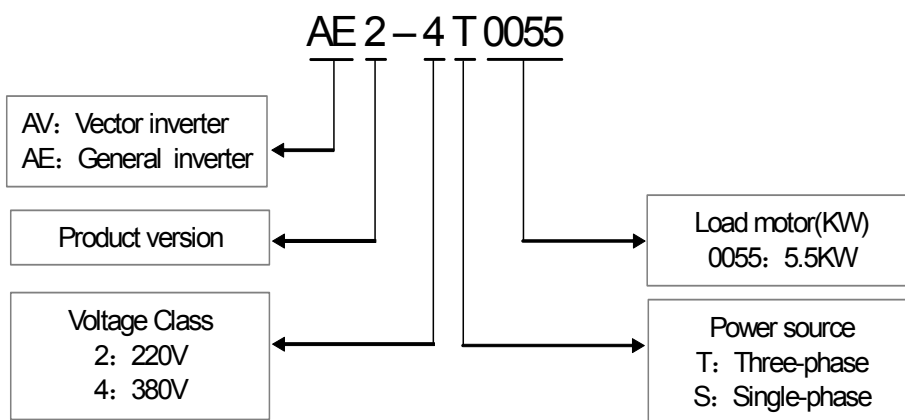

### 1.2 Appearance description

#### 1.2.1 Appearance of model I

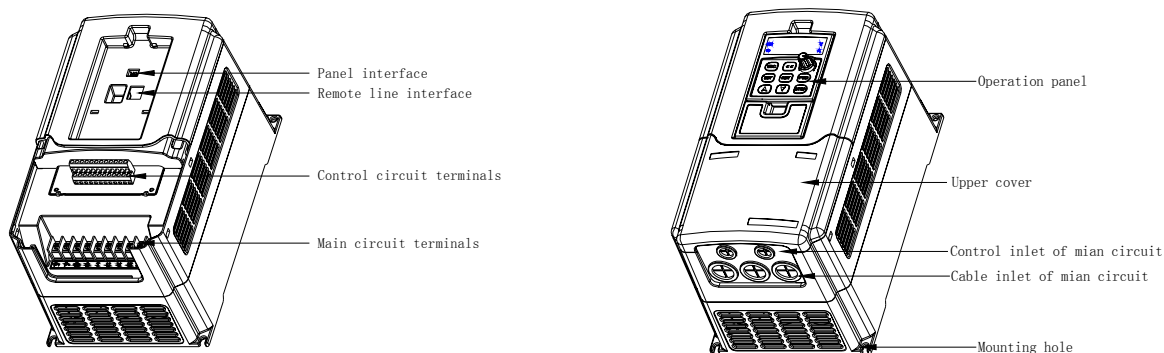

It is fit for: AE2-4T0015~AE2-4T0075 / AE2-2T0015~AE2-2T0037 / AE2-2S0015~AE2-2S0037

### 1.2.2 Appearance of model II

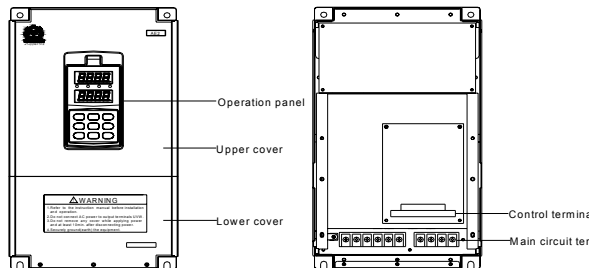

It is fit for: AE2-4T0110~AE2-4T0750 / AE2-2T0055~AE2-2T0450

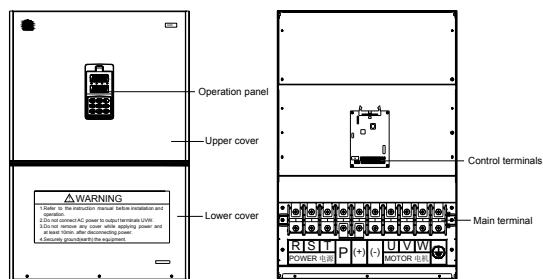

It is fit for: AE2-4T0900~AE2-4T1100 / AE2-2T0550

### 1.2.3 Appearance of model III

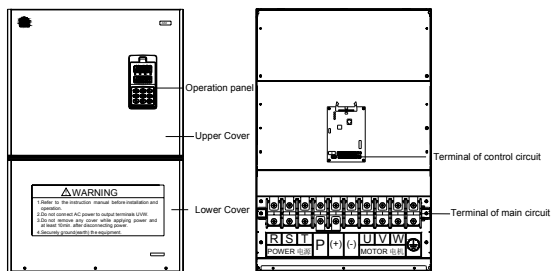

It is fit for: AE2-4T1320~AE2-4T2000/ AE2-2T0750~AE2-2T1100

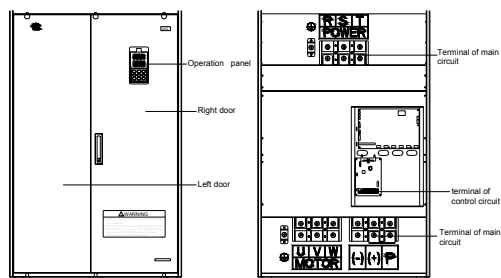

It is fit for: AE2-4T2200~AE2-4T2800

## 1.2.4 Appearance of model IV

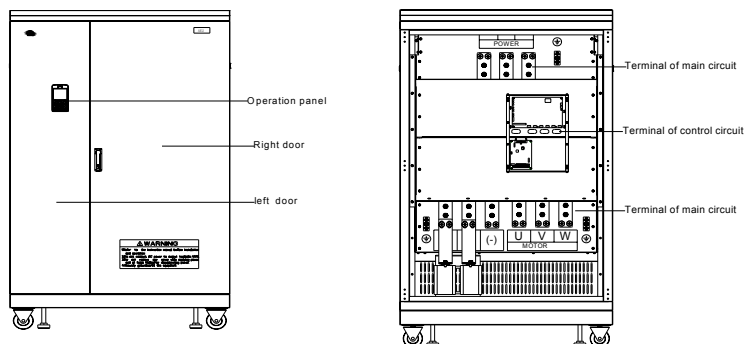

It is fit for: AE2-4T3150~AE2-4T4000

## 1.3 Model of Inverter

Model	General lode (G-load) ([F0.15]=0)			Pump and fan lode (P-load) ([F0.15]=1)		
	Rated Power (KVA)	Rated output current (A)	Applied Motor Power (KW)	Rated Power (KVA)	Rated output current (A)	Applied Motor Power (KW)
AE2-2S0015	2.9	7.5	1.5	--	--	--
AE2-2S0022	3.8	10	2.2	--	--	--
AE2-2S0037	5.7	15	3.7	--	--	--
AE2-2T0015	2.9	7.5	1.5	--	--	--
AE2-2T0022	3.8	10	2.2	--	--	--
AE2-2T0037	5.7	15	3.7	--	--	--
AE2-2T0055	9.5	25	5.5	--	--	--
AE2-2T0075	12.6	33	7.5	--	--	--
AE2-2T0110	17.5	46	11	--	--	--
AE2-2T0150	22.9	60	15	--	--	--
AE2-2T0185	28.6	75	18.5	--	--	--
AE2-2T0220	32.4	85	22	--	--	--
AE2-2T0300	41.9	110	30	--	--	--
AE2-2T0370	51.5	135	37	--	--	--
AE2-2T0450	64.8	170	45	--	--	--
AE2-2T0550	78.1	205	55	--	--	--
AE2-2T0750	101	265	75	--	--	--
AE2-2T0900	122	320	90	--	--	--
AE2-2T1100	145	380	110	--	--	--
AE2-4T0015	2.4	3.7	1.5	3.6	5.5	2.2
AE2-4T0022	3.6	5.5	2.2	5.6	8.5	3.7
AE2-4T0037	5.6	8.5	3.7	8.6	13	5.5
AE2-4T0055	8.6	13	5.5	11	17	7.5
AE2-4T0075	11	17	7.5	16.5	25	11
AE2-4T0110	16.5	25	11	21.7	33	15
AE2-4T0150	21.7	33	15	25.7	39	18.5
AE2-4T0185	25.7	39	18.5	29.6	45	22
AE2-4T0220	29.6	45	22	39.5	60	30



AE2-4T0300	39.5	60	30	49.4	75	37
AE2-4T0370	49.4	75	37	60	91	45
AE2-4T0450	60	91	45	73.7	112	55
AE2-4T0550	73.7	112	55	98.7	150	75
AE2-4T0750	98.7	150	75	116	176	90
AE2-4T0900	116	176	90	138	210	110
AE2-4T1100	138	210	110	171	260	132
AE2-4T1320	171	260	132	204	310	160
AE2-4T1600	204	310	160	237	360	185
AE2-4T1850	237	360	185	253	385	200
AE2-4T2000	253	385	200	276	420	220
AE2-4T2200	276	420	220	313	475	250
AE2-4T2500	313	475	250	352	535	280
AE2-4T2800	352	535	280	395	600	315
AE2-4T3150	395	600	315	424	645	350
AE2-4T3500	428	650	350	480	730	400
AE2-4T4000	480	730	400	513	800	450

## 1.4 Specifications

Input	Rated voltage and freq.		Three-voltage (4T****) 380V 50/60Hz	Three-voltage (2T****) 220V 50/60Hz	Single-voltage (2S****) 220V 50/60Hz	
	Permissible voltage fluctuation		Three-voltage (4T****) 300V~460V	Three-voltage (4T****) 170V~270V	Three-voltage (4T****) 170V~270V	
Output	Voltage		Three-voltage: 0~380 V	Single-voltage: 0~220 V		
	Frequency		0 Hz ~600Hz			
	Over-loading Endurance		110% rated current for long-term; 150% rated current for 1min; 180% rated current for 2s			
Control System			VVVF control			
Control Characteristics	Freq. Control Resolution	Analog Input	0.1% of maximum output freq.			
		Digital Input	0.01Hz			
		External pulse	0.1% of maximum freq.			
	Freq. Precision	Analog Input	Within 0.2% of maximum output freq.			
		Digital Input	Within 0.01% of setting freq.			
		External pulse	0.1% of maximum freq.			
	V/F Curve (Voltage-Frequency characteristics)		Reference freq. can be discretionary set between 5 and 300Hz. And V/F curve with multimode can be discretionary set. There are also three curves provided, constant torque curve, Dec torque curve 1 and Dec torque curve 2.			
	Torque boost		Manual torque boost can be set between 0 and 20 percent; Automatic torque boost can be set according to output current.			
	Automatic current/voltage Limiting		It will determine automatically the current and voltage of stator of motor, which will be controlled within the allowable range.			
	Under voltage inhibit feature In running		It is especial for the users with lower-power supply and voltage fluctuate frequently, even the voltage is lower than Permissible voltage, and the system will maintain the longest running time.			

Typical Functions	Multi-speed selection And Wobble freq. running		Up to 8 stages of programmable multi-speed control, 6 kinds of running mode and 15 stages of multi-speed. Wobble freq. function is composed of preset freq., center freq. adjusted and save state and restart when inverter just had power off.
	Embedded PID control		Optional inner bipolar PID controller, 5-pump voltage regulation control system (supply water or gas), with sleep/ wake up, a typical energy-saving function.
	RS485 communication and synchronization control		Through RS485 communication, master inverter is the role of synchronous controller linkage controlling proportion presupposition and trimming, slave inverter running frequency superposition and trimming internal. In system of multi-gearing series use, have load self-equalized function, all gearing load proportion according to pre-set to keep consistent strictly.
	Freq. Setting	Analog input	DC voltage 0~5V、0~10V, DC current 0~20mA
		Pulse input	Its amplitude value is between 5 and 30V、 and its freq. is within 50.0KHz
		Digital input	It can set by operation panel, RS485, UP/DW terminal, also can set multiple combinations with analogue input.
	Output Signal	OC output	Two OC output, As many as 16 species of choice, fault relay output similarly optional.
		Analog output	Two 0~10V voltage or 0~20 mA current signal, Upper and lower limits can be set separately.
	Automatic energy saving running		The output current timely adjust output voltage and slip compensation, the motor has been working at the highest efficiency. According to the status of the scene automatic energy saving operation can set the depth. In particular, it suitable for ball-mill and other energy-saving field of micro-adjustment frequency.
	Voltage stabilizing running Automatically		Three ways for selection: Dynamic voltage regulation、 Static Voltage regulation、 No Voltage regulation, to get the most stable operating result
	Acceleration/deceleration Time setting		0.1Sec~6000min Continuous set, S type 、 linear mode for selection
	Brake	Regenerative braking	75% above
		DC braking	Start and stop can be select respectively, action freq. is from 0 to 50.0Hz
Determine speed and restart		To achieve Smoothing restart and instantaneous-stop restart function of running motor.	
Counter、 Timer		Embedded one timer and one counter, which will help the system's integration.	
Operation functions		Upper and Lower frequency setting, frequency skip operation, Reversal operating restriction, Slip frequency compensation, automatic stable voltage operation, RS485 communication, frequency increasing/decreasing control, fault recovery operation.	
Display	Operation panel display	Running status	Output Freq., Output current, Output voltage, Motor rotate speed, Setting Freq., Model temperature, PID setting, PID feedback, Analog I/O
		Alarm content	Last running parameters' record: Last six fault record, Output frequency of last fault trip、 Setting frequency、 Output current、 Output voltage、 DC voltage、 Model Temperature
Protection / Warning functions			Over current, over voltage, under current, under voltage, electronic thermal, overheating, extreme high temperature, short circuit, Phase-lacking of output, internal memory fault
Environmental Conditions	Ambient temperature		-10°C to +50°C
	Ambient humidity		Under 90% (non-condensing)
	Ambient environment		Indoors (no inflammable gasses or dust)
	Altitude		Lower than 1000m
Configuration	Enclosure rating		IP20
	Cooling method		Fans cooling
Installation			Hanging

## 2. INSTALLATION GUIDELINES

### 2.1 Environmental requirements:



1. Be sure to install the inverter in a well-ventilated room.
2. Ambient temperature is from  $-10^{\circ}\text{C}$  to  $40^{\circ}\text{C}$ . If the temperature is  $40^{\circ}\text{C}$  to  $50^{\circ}\text{C}$ , please take out the lower cover to cool.
3. Please avoid putting the inverter in a high temperature and moist location. The humidity is less than 90% and non-condensing.
4. Keep away from combustibile, explosive material and caustic gas or liquid.
5. No dust, floating fiber and metal particles
6. The inverter must be installed in a firm and no vibration location.
7. The installation plane should be solid and not vibrant.

If users demand any special installation, please contract us firstly.

AE2series inverter is hanging model, so it should be in vertical way. In order to ensure the air circulation around the inverter to aid in cooling, there should be enough space around the inverter shown as Fig. 2-1-A. Add the air deflector when apply the up-down installation shown as Fig. 2-1-B.

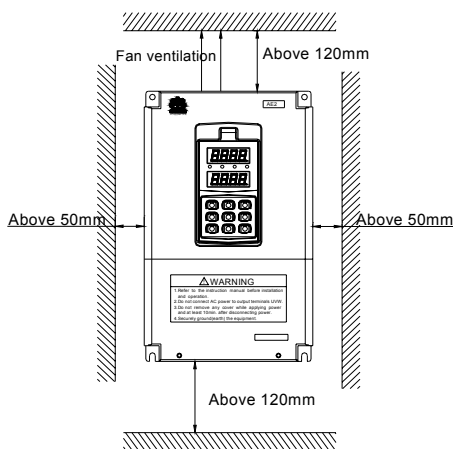

Fig2-1-A Interval distance

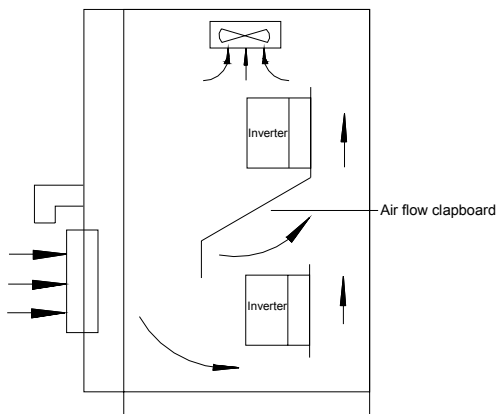

Fig2-1-B Multi-inverter Installation

### 2.2 Disassembly and assembly of the panel

#### Disassembly

Put your middle finger into "open hole". Then gently press the fixed spring on the top of panel. Then pull outward to remove the panel.

#### Assembly

Aim the fixed hook to spring clip at bottom of operation panel, then press the fixed spring backward. Then push inward to the certain place. Shown as Fig. 2-2.

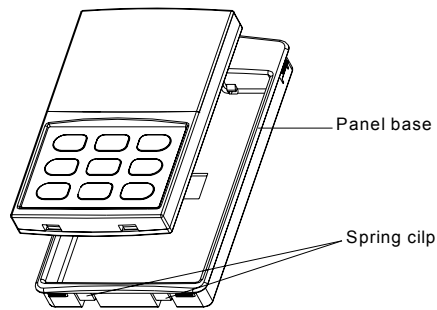

Fig.2-2 Disassembly and assembly of the panel

## 2.3 Disassembly and assembly of the cover board

### 2.3.1 Disassembly and assembly of plastic cover board

It is fit for: AE2-4T0015~AE2-4T0075 /AE2-2T0015~AE2-2T0037 /AE2-2S0015~AE2-2S0037

#### Disassembly

Put the finger into the “portable hole”, pull upward to move the cover form the shell, then pull downward, which will remove the cover board.

#### Assembly

Lift the bottom of cover up to about 15°C, inserting the “Fixed hook” into the hold down groove, then press the cover down to hear a sound of “Click”, which means the cover board has already been mounted and shown as Fig. 2-3-A.

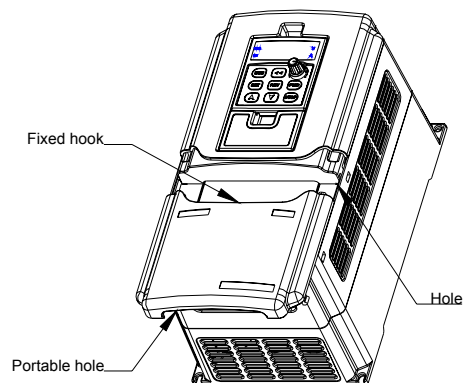

Fig2-3-A Disassembly and assembly of plastic cover board

### 2.3.2 Disassembly and assembly of lower cover board

It is fit for: AE2-4T0110~AE2-4T0750/

AE2-2T0055~AE2-2T0450

#### Disassembly

1. Take two screws at bottom of lower cover board.
2. Move the lower cover board downward.

## Assembly

1. Put the lower cover board parallel with the interval.
2. Move the lower cover board upward.
3. Screw the bottom of lower cover board.

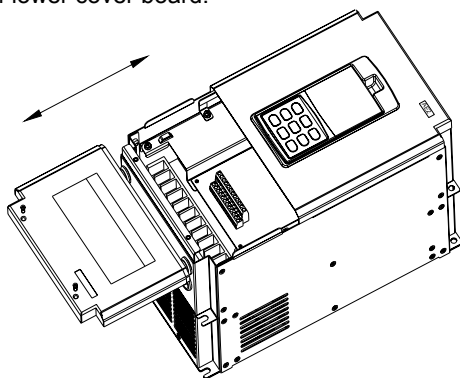

Fig.2-3-B Disassembly and assembly of lower cover

## 2.4 Dimension of inverter

### 2.4.1 Model I

It is fit for: AE2-4T0015~AE2-4T0075 / AE2-2T0015~AE2-2T0037 / AE2-2S0015~AE2-2S0037.

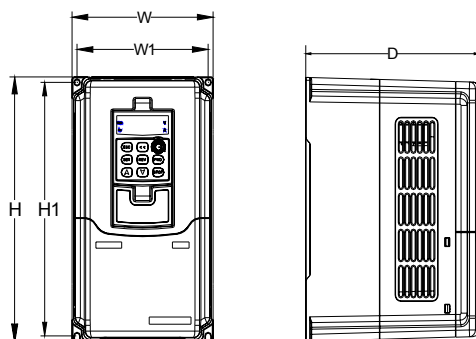

Fig2-4-A Dimension of model I

### 2.4.2 Model II

It is fit for: AE2-4T0110~AE2-4T0750/ AE2-2T0055~AE2-2T0450.

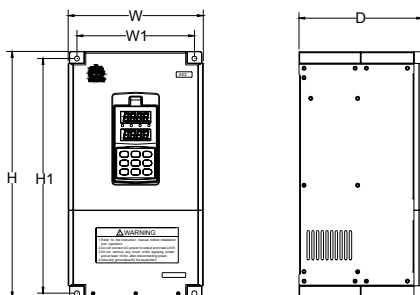

Fig2-4-B Dimension of model II

### 2.4.3 Model III

It is fit for: AE2-4T0900~AE2-4T2000/ AE2-2T0900.

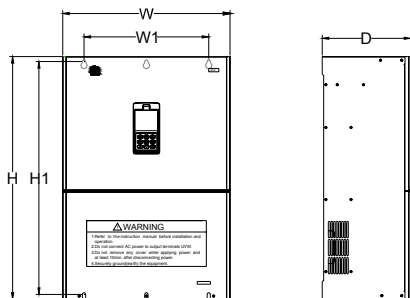

Fig 2-4-C Dimension of model III

### 2.4.4 Model IV

It is fit for: AE2-4T2200~AE2-4T2800.

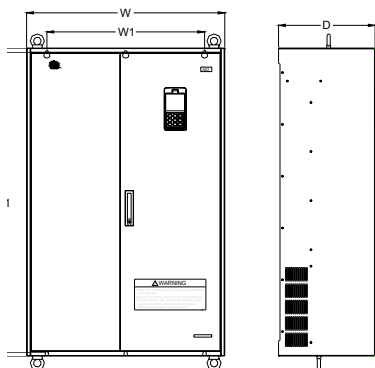

Fig 2-4-D Dimension of model IV

### 2.4.5 Model V

It is fit for: AE2-4T3150~AE2-4T4000.

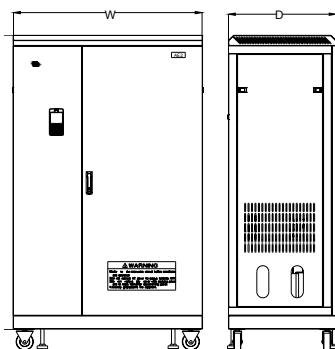

Fig 2-4-E Dimension of model V

Installation dimension of inverter, AE2 is shown as following table:

Inverter model (3-phase 400V)	Inverter model (1-phase 220V)	Inverter model (3-phase 220V)	W1 (mm)	W (mm)	H1 (mm)	H (mm)	D (mm)	Screw
AE2-4T0015	AE2-2S0015	AE2-2T0015	123	134	223	234	165	M4
AE2-4T0022	AE2-2S0022	AE2-2T0022						
AE2-4T0037	--	--						
AE2-4T0055	AE2-2S0037	AE2-2T0037	157	169	282	294	178	M5
AE2-4T0075	--	--						
AE2-4T0110	--	AE2-2T0055	184	204	328	344	199	M6
--	--	AE2-2T0075						
AE2-4T0150	--	AE2-2T0110	200	230	400	420	211	M6
AE2-4T0185	--	--						
AE2-4T0220	--	AE2-2T0150	232	260	450	470	233	M8
AE2-4T0300	--	AE2-2T0185						
AE2-4T0370	--	AE2-2T0220	271	300	545	567	250	M8
AE2-4T0450	--	AE2-2T0300						
AE2-4T0550	--	AE2-2T0370	344	381	588	614	298	M8
AE2-4T0750	--	AE2-2T0450						
AE2-4T0900	--	AE2-2T0550	380	510	710	740	270	M8
AE2-4T1100	--	--						
AE2-4T1320	--	AE2-2T0750	400	580	760	793	300	M10
AE2-4T1600	--	AE2-2T0900						
AE2-4T1850	--	--	550	700	960	1000	340	M10
AE2-4T2000	--	--						
AE2-4T2200	--	--	580	730	1103	1130	355	M10
AE2-4T2500	--	--						
AE2-4T2800	--	--						
AE2-4T3150	--	--						
AE2-4T3500	--	--	--	--	--	--	--	--
AE2-4T4000	--	--	--	--	--	--	--	--

### 3. WIRING PROCEDURE

#### 3.1 Precautions

- 3.1.1. Installing a middle breaker between inverter and power supply in order to avoid enlarging the accident.
- 3.1.2. Reducing the electromagnetic interference (EMI), please connect surge absorber to the coils of electromagnetic contactors, relays, etc.
- 3.1.3. Frequency setting terminals (VC1, VC2, CC and PLS), Instrument circuit (AO1 and AO2), etc., these analog signal wires should be over  $0.3\text{mm}^2$  shield wire. Shield layer is connected with earth terminal GND and the length of wire should be than 30m.
- 3.1.4. Wire of relay input and output circuit(X1 ~ X6, OC1, OC2, FWD、REV、RST) must be selected over  $0.75\text{mm}^2$  shield wire. Shield layer should be connected to earth terminal CM and the length of wire should be shorter than 50m.
- 3.1.5. Separating the main circuit wire from the signal/process circuit wiring, paralleled wiring should be at a distance of over 10cm and crossed wiring should be vertical with each other. .
- 3.1.6. The wire must be less than 30m between motor and inverter. When the length of wire is over 30m, the carrier frequency of inverter should be reduced properly.
- 3.1.7. All of leading wires should be tightened with the terminal adequately to ensure well-contact. The leading wire of main circuit had better use the cable or cuprum tier, and wiring had better be operated after the lug plate of corresponding section's cold pressing or welding.
- 3.1.8. Compressive resistance of all the wire should match with the voltage grade of inverter.



It is not allowed that U、V、W of inverter connect with the surge absorber capacitor or other surge absorber equipment and shown as following Fig..

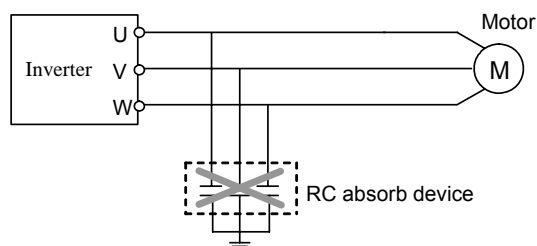

#### 3.2 Wiring of External Components

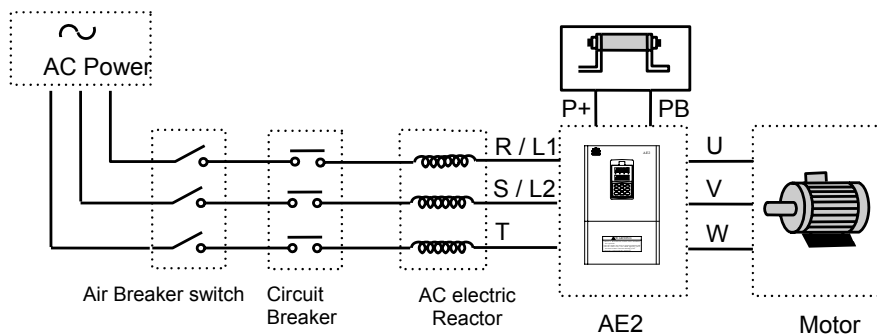



- Power Supply  
It is according to the rated input power specifications in manual
- Air-break switch
  1. When the inverter is in maintenance or leave-unused, the air-break switch should isolate the inverter from power supply.
  2. Input side of inverter takes place the fault of short-circuits or low-voltage, the air-break would take the protection.
- Contactor  
Control the power-on or power-off of inverter expediently.
- AC electric reactor
  1. Improve the power factor.
  2. Reduce the harmonic wave input for the electric network.
  3. Weaken the imbalance effect on 3-phase power voltage.
- Brake resistor

In the situation of regenerative braking, avoiding bringing voltage too highly.

Recommending specification of commanded equipment is shown as following table.

Model	Applied Motor (KW)		Wire spec (Main circuit) (mm <sup>2</sup> )	Air-break (A)	Magnetic contactor (A)
	G-load	P-load			
AE2-2S0015	1.5	--	4	20	18
AE2-2S0022	2.2	--	6	32	18
AE2-2S0037	3.7	--	6	40	32
AE2-2T0015	1.5	--	4	20	18
AE2-2T0022	2.2	--	4	20	18
AE2-2T0037	3.7	--	6	40	25
AE2-2T0055	5.5	--	10	63	32
AE2-2T0075	7.5	--	10	63	38
AE2-2T0110	11	--	16	100	50
AE2-2T0150	15	--	25	160	80
AE2-2T0185	18.5	--	25	160	80
AE2-2T0220	22	--	25	160	95
AE2-2T0300	30	--	50	200	150
AE2-2T0370	37	--	50	250	170
AE2-2T0450	45	--	70	250	170
AE2-2T0550	55	--	95	400	225
AE2-2T0750	75	--	95	400	330
AE2-2T0900	90	--	150	630	330
AE2-4T0015	1.5	2.2	2.5	16	12
AE2-4T0022	2.2	3.7	4	16	12
AE2-4T0037	3.7	5.5	4	20	18
AE2-4T0055	5.5	7.5	6	32	18
AE2-4T0075	7.5	11	6	40	25
AE2-4T0110	11	15	10	63	32
AE2-4T0150	15	18.5	10	63	38
AE2-4T0185	18.5	22	16	100	50
AE2-4T0220	22	30	16	125	50

Model	Applied Motor (KW)		Wire spec (Main circuit) (mm <sup>2</sup> )	Air-break (A)	Magnetic contactor (A)
	G-load	P-load			
AE2-4T0300	30	37	25	160	80
AE2-4T0370	37	45	25	160	95
AE2-4T0450	45	55	50	200	115
AE2-4T0550	55	75	50	200	150
AE2-4T0750	75	90	70	250	170
AE2-4T0900	90	110	70	315	225
AE2-4T1100	110	132	95	400	225
AE2-4T1320	132	160	95	400	330
AE2-4T1600	160	185	150	630	330
AE2-4T1850	185	200	150	630	400
AE2-4T2000	200	220	185	630	400
AE2-4T2200	220	250	185	800	500
AE2-4T2500	250	280	240	800	500
AE2-4T2800	280	315	240	1000	630
AE2-4T3150	315	350	300	1250	630
AE2-4T3500	350	400	300	1250	780
AE2-4T4000	400	450	400	1600	780

### 3.3 Basic wiring

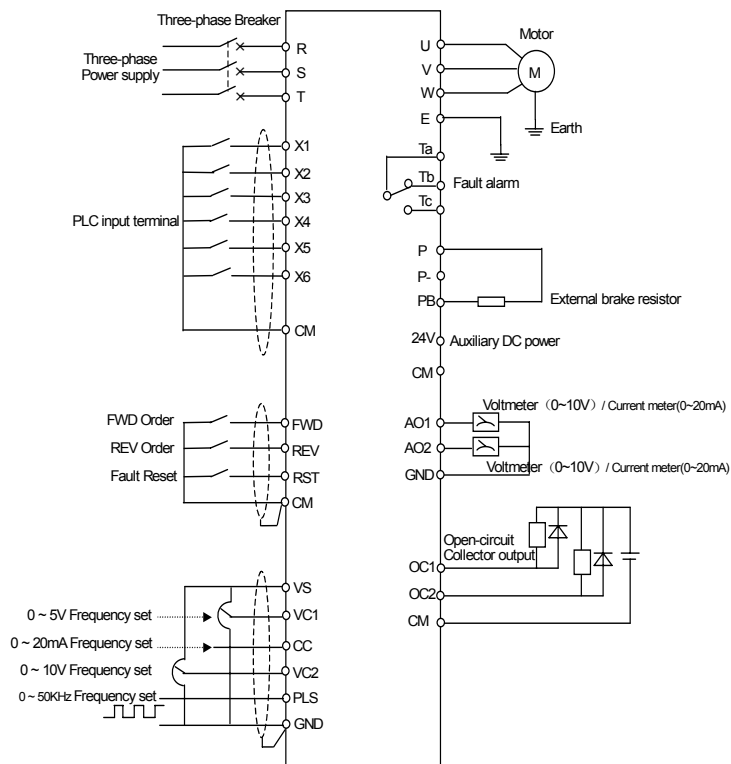

### 3.4 Terminal of main circuit

#### 3.4.1 I model (It is fit for AE2-4T0015~AE2-4T0075 / AE2-2T0015~AE2-2T0037)

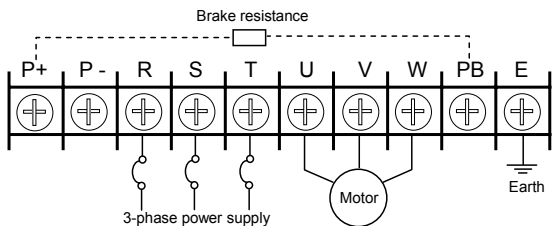

#### 3.4.2 II model (It is fit for AE2-4T0110~AE2-4T0150 / AE2-2T0055~AE2-2T0110)

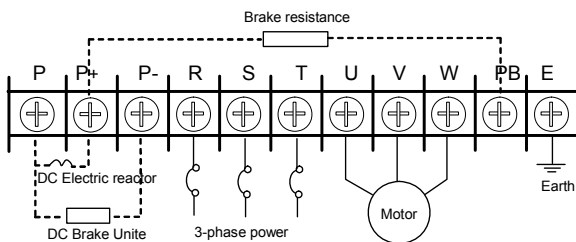

#### 3.4.3 III model (It is fit for: AE2-4T0185~AE2-4T0300AE2-4T1320~AE2-4T2000 / AE2-2T0150~AE2-2T0185)

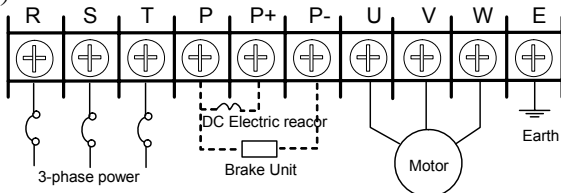

#### 3.4.4 IV model (It is fit for: AE2-4T0370~AE2-4T1100 / AE2-2T0220~2T0550)

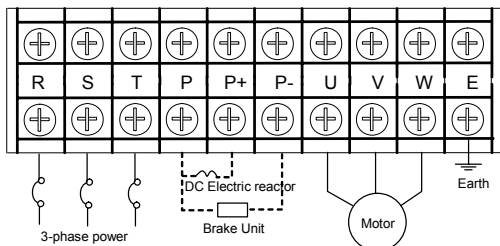

#### 3.4.5 V model (It is fit for: AE2-4T2200~AE2-4T2800)

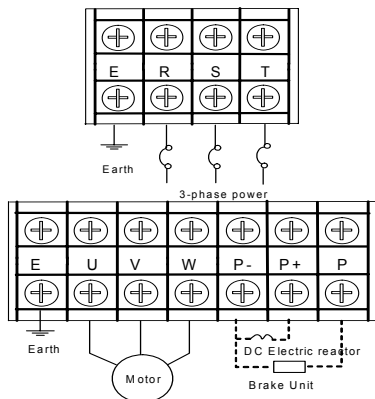

### 3.4.6 VI model (It is fit for: AE2-4T3150~AE2-4T4000)

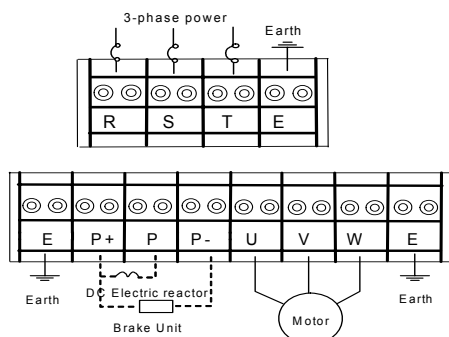

Description of terminal:

Terminal	Function
P	Positive Terminal of DC Negative
P-	Negative Terminal of DC / DC brake unite can be connected between P and P-.
P+	DC electric Reactor can be connected between P and P+.
PB	DC brake resistance can be connected between P and PB.
R、S、T	Connecting three-phase AC power supply
U、V、W	Connecting three-phase AC motor
E	Earth Terminal

### 3.5 Terminal of Control circuit

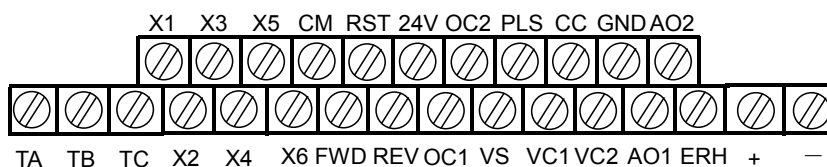

Description of control-circuit terminal:

Type	Terminal	Function	Notes
Analog Input	VS	It provides +10V/10mA or +5V/50mA power to JP1	Switch JP1
	VC1	Frequency setting voltage signal input terminal 1	0~5V
	VC2	Frequency setting voltage signal input terminal 2	0~10V
	CC	Frequency setting current signal input terminal	0~20mA
	PLS	Pulse input signal terminal	0~50KHz/5~30V
	GND	Common terminal of Frequency setting voltage signal	
Control Terminal	X1	Multi-function input terminal 1	The detailed function of multi-function Input terminal is by set parameter F3.0~F3.5, The terminal is valid while being closed with CM terminal.
	X2	Multi-function input terminal 2	
	X3	Multi-function input terminal 3	
	X4	Multi-function input terminal 4	
	X5	Multi-function input terminal 5	
	X6	Multi-function input terminal 6	

Control Terminal	FWD	FWD control command terminal	Those terminals are valid when it connects with CM. And running direction of panel control is controlled by FWD-CM state
	REV	REV control command terminal	
	RST	Fault reset input terminal	
	CM	Common terminal of control	
	24V	It provides +24V/50mA power and is grounded by CM.	
Analog Output	AO1	PLC voltage signal input terminal1. It is set by F2.13 and allowed to connect with external voltmeter.	voltage signal output : 0~20mA/0~15V. Voltage signal output : 0~10V/1mA Switch JP2、JP3 select voltage or current
	AO2	PLC voltage signal input terminal 2. It is set by F2.14 and allowed to connect with external voltmeter.	
	GND	Common terminal of AM1and AM2	
OC Output	OC1	PLC open-circuit collector output is set by F3.6 and F3.7	The maximum load-current is 50mA, while the maximum withstand voltage is 24V.
	OC2		
PLC output	TA	General , TA-TB is connected, TA-Tc is unconnected when TA-TB is unconnected and TA-TC is connected, F3.8 is valid.	Capacity: AC 250V 1A Resistive load
	TB		
	TC		
RS485 Interface	+	RS485 interface	
	-		
ERH		Grounding terminal	

Explanation about JP:

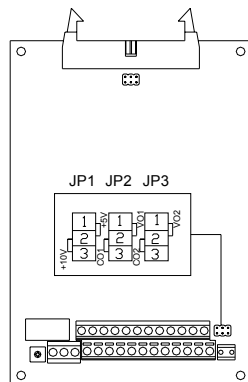

JP1:

- 1-2shorted: Input +5V/50mA signal
- 2-3shorted: Input +10V/10mA signal

JP2:

- 1-2 shorted: AO1input voltage signal
- 2-3 shorted: AO1 input current signal

JP3:

- 1-2 shorted: AO2 input voltage signal
- 2-3 shorted: AO2 input current signal

## 4. OPERATIONS OF INVERTER AND SIMPLE RUNNING

Operation panel has two functions: One is to modify the running state parameters. The other is to check and modify the internal parameters. So operation panel has two modes : Modify mode, check and modify parameters mode.

Usually, operation panel mode is in normal modify mode when inverter is just power-on. At this time, current running parameter , which is shown on operation panel , is controlled by F6.12、 F6.13. The operation panel mode will return the normal modify mode, if there isn't any operation on panel in 1 min.

### 4.1 Operation panel

#### 4.1.1 Panel layout

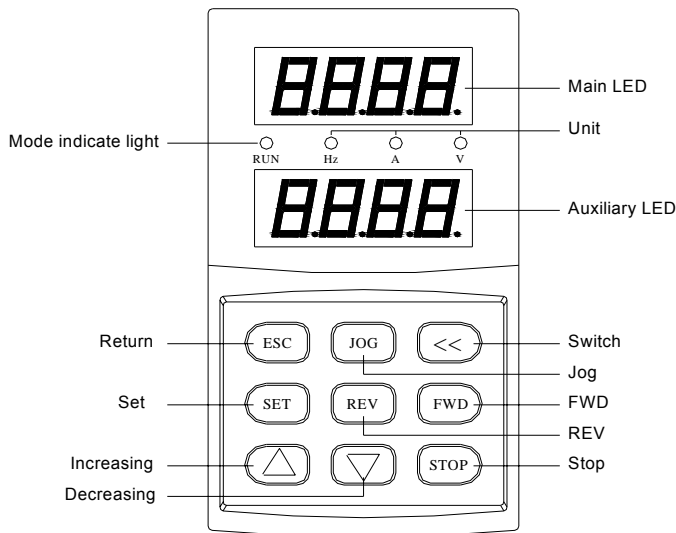

Fig.4-1-A Panel layout

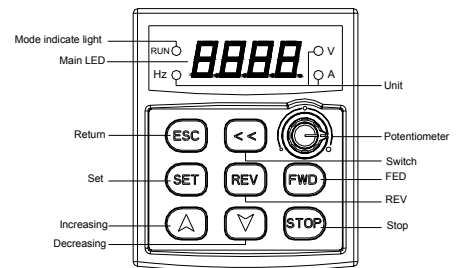















Fig.4-1-B Small Panel layout

Item		Function
Display	Main LED	It displays current state and setting parameter.
	Auxiliary LED	It displays current state and setting parameter. At the beginning of power supply, it displays inverter's program version, and it will return normality in 2 second. Small panel layout doesn't have this auxiliary LED.
	A、Hz、V	The corresponding unit of current display
	RUN	Operation indicator light. The inverter is running and U, V and W output voltage.
Keypad	<b>FWD</b>	FWD key When F0.1 is 0 and press this key, the inverter will running forward to setting frequency according to appointed ACC or DEC curve.
	<b>REV</b>	REV key When F0.1 is 1 and press this key, the inverter will be running backward to setting frequency according to appointed ACC or DEC curve.

Keypad		Stop and Reset key When F0.4 is 000#, STOP is valid for panel control. If F0.4 is 001#, STOP is valid for all kinds of control methods. If inverter occur fault, press this key to reset it and return stop mode. If stop key is used together with  , copy and read-in of internal parameters will be done.
		Return key Press this key in normal modify state to enter query mode of not normal modify state /modify parameters to check running state. In any state, press this key to return the upper state. This key is used together with  to perform Parameter read / backup.
		Set key This key is used together with  to perform Parameter copy / write.
	 	Data modify key It is used to modify the function code and parameter. In state modify mode, if F0.1 is 0, press this key will modify the frequency instruction
		Jog key. It is valid when the state is only in operation panel control pattern
		Shift key. In any state, press   key to modify data's state. Press the key to modify the digital bit, the modification bit will be displayed blink. This key is used together with  to perform Parameter read / backup.
		Panel potentiometer. This button is used for setting Inverter's running freq.. Turning left the button is to decrease running freq. ,turning right the button is to increase running freq.



## 4.2 Basic function of panel and methods of operation



### 4.2.1 Basic functions of panel

Operation panel have functions of FWD running, REV running, JOG running, Stop, Fault reset, Modify and check of parameter and Monitor running parameter, besides other function as follows:

#### (1) Parameter read / backup

This function provides to copy the internal parameter of inverter and saves it permanently. (Only limit to open internal parameter). So user can copy typical settings parameters to operate panel. These parameters don't affect inverter running, and are checked out and modified separately.

Press  and  key simultaneously to enter parameter read / backup. Even if the inverter is running, reading parameters is also carried though. When parameters are read, "0" is displayed blink from right to left. After parameters backup is finished, the display is normal.

In process of parameters backup, it can be cancelled by pressing  or . And press  key to return the normal monitor state.

#### (2) Parameter copy / write

This function provides to copy the backup parameter of inverter and saves to inner storage of inverter. (Only limit to open internal parameter) So user can copy typical settings parameters to operate panel. Those parameters don't affect inverter running, and are checked and modified separately.

Please set F6.16 as 1 and stop the inverter before write parameter. After writing, set F6.16 as 0 to prevent invalid parameters saving in inverter. And it had better copy the valid inner parameter to operation panel.

Please stop the inverter and then press **SET** and **STOP** key simultaneously to enter parameter copy / write under normal monitor mode. When parameters are writing, "0" is displayed blink from right to left. After parameters copy is finished, the display is normal.

In process of parameters copy, it can be cancelled by pressing **ESC** or **SET**. And press **ESC** key to return the normal monitor state.

### (3) Modify and check the internal parameter

Press **SET** key to enter Modify and check internal parameter mode under normal mode with general ways to check and modify data.

### (4) Modify and check the backup parameter

Under normal monitor mode, press **<<** and **SET** key simultaneously to enter Modify and check the backup parameter mode. When panel displays function code, "F" in the fourth place of main LED will be displayed blink, which means current modify and check parameters is backup parameter.

## 4.2.2 Methods of panel operation

### (1) State parameter inquiry (eg.)

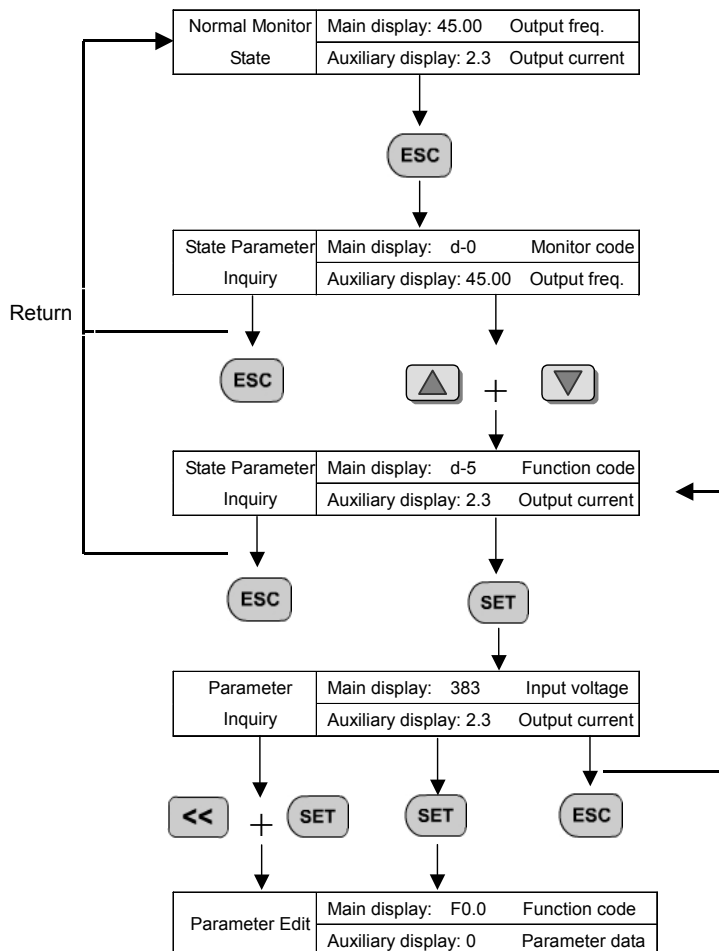



(2) Parameter inquiry and modify (eg.)

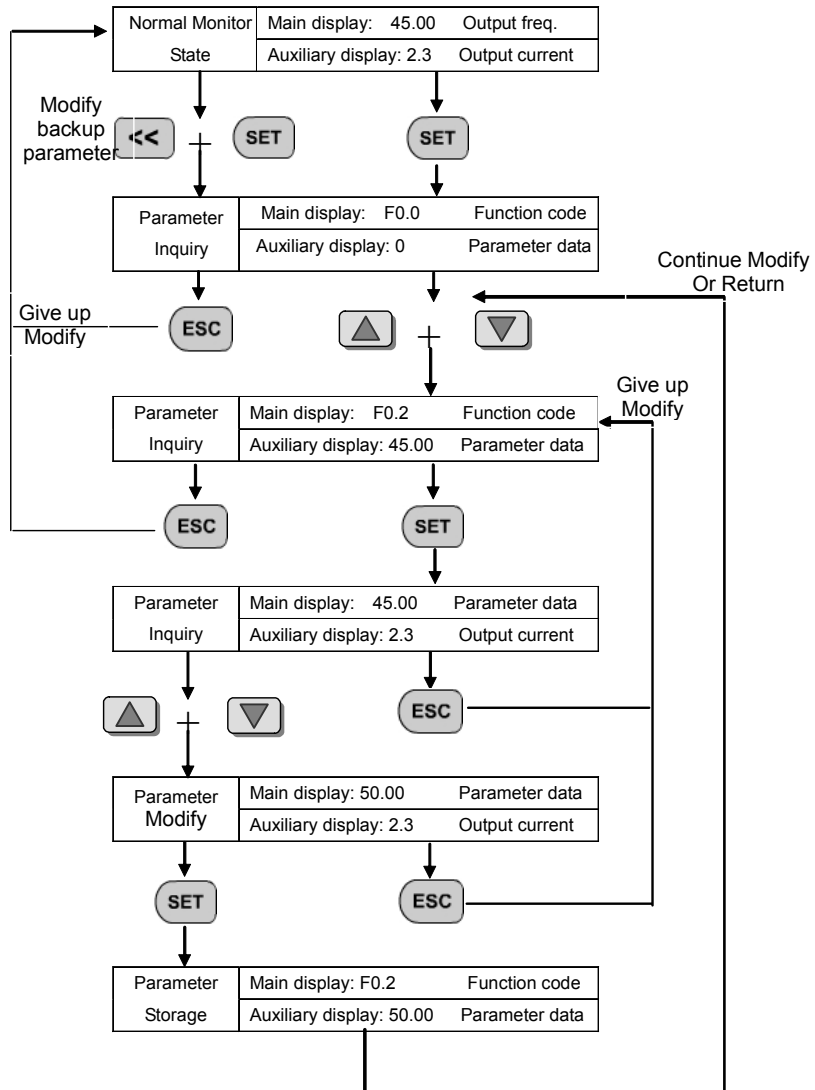

### 4.3 List of State monitor parameter

Monitor Code	Content	Unit
d.0	Current output frequency	Hz
d.1	Current output current	A
d.2	Current output voltage	V
d.3	Rotate speed of motor	rpm
d.4	DC bus voltage	V
d.5	Input voltage of inverter	V
d.6	Setting freq.	Hz
d.7	Count value of Internal counter	
d.8	PID setting value	
d.9	PID feedback value	
d.10	Running linear speed	
d.11	Setting linear speed	
d.12	Analog input voltage VC1	V
d.13	Analog input voltage VC2	V
d.14	Analog input voltage CC	mA
d.15	External pulse input PLS	KHz
d.16	State of input terminal	
d.17	Temperature of module	°C
d.18	Analog output AO1	
d.19	Analog output AO2	
d.20	Reserved	
d.21	Reserved	
d.22	Reserved	
d.23	Reserved	
d.24	Reserved	
d.25	Reserved	
d.26	First fault record	
d.27	Second fault record	
d.28	Third fault record	
d.29	Fourth fault record	
d.30	Fifth fault record	
d.31	Sixth fault record	
d.32	Output frequency of last fault	Hz
d.33	Setting frequency of last fault	Hz
d.34	Output current of last fault	A
d.35	Output voltage of last fault	V
d.36	DC voltage of last fault	V
d.37	Temperature of module of last fault	°C

## 4.4 Simple Operation

### 4.4.1. Initialization

(1) Frequency input channel / mode selection ([F0.1])

Initialization of inverter is different according to different model. If [F0.0] is 0, the frequency of inverter is set by keypad.

(2) Operation channel selection ([F0.4])

Initialization of inverter is different according to different model. If F0.4 is 00#0, Start and stop of inverter is controlled by **FWD** and **STOP** key.

### 4.4.2. Simply operation



➤ It is forbidden to connect Three-phase power to output terminal U, V and W directly.

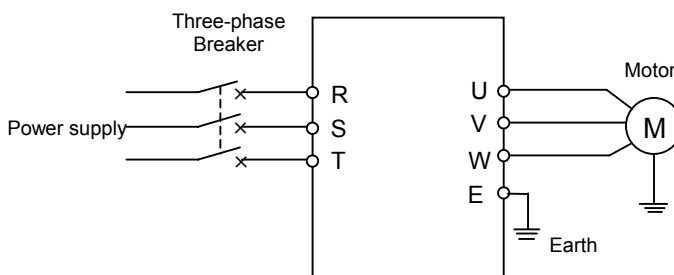

Fig.4-1 simply running

- ① Please wire as the Fig 4-1.
- ② Be sure that the wiring is correct and turn the power on, the inverter will display "P.oFF" and "0". Auxiliary LED displays the program version temporarily.
- ③ Be sure that F0.1 is 0.
- ④ Please set parameters [F1.3] and [F1.4], according to the nameplate parameters of applied motor.
- ⑤ Please press **FWD** key to start inverter, then the inverter will display 0.0Hz.
- ⑥ Please press **▲** key to increase input frequency and motor will run.
- ⑦ Observe the motor whether it runs normally or not. If abnormal, please stop running at once and turn off the power, and find out the reason, then restart.
- ⑧ Press the key **▼** to decrease the setting frequency.
- ⑨ Press the key **STOP** to stop running. Then turn power supply off.



➤ Carrier wave frequency is fixed value between 1.5 and 10 KHz. If motor does not take any load, it will a slight oscillate. So please decrease setting value of F0.16, Or setting Oscillatory inhibiting factor value of FC.11.

## 5. PARAMETERS LIST

Symbol description:

★ means that this parameter can not be change during operation.

▲ means that this parameter is related to the inverter's model.

Function	Code	Name	Setting range	Minimum Setting	Manufactur Setting	Modify Limit
Basic operation parameter unit	F0.0	Reserved		1	0000	★
	F0.1	Frequency input channel / mode selection	0: Frequency setting by operation panel 1: UP/DW Acc and Dec control 2: RS485 interface 3: Panel potentiometer 4: External voltage signal VC1 (0V~5V) 5: External voltage signal VC2 (0V~10V) 6: External current signal CC (0~20mA) 7: External pulse signal (0.0~50.0KHz) 8: Combination setting 9: External terminals	1	0	
	F0.2	Frequency digital setting	0.00~ the upper limit frequency	0.01	0	
	F0.3	Auxiliary control of freq. Digital setting	The first part of LED(form right to left): 0: Setting freq. will save after power down 1: Setting freq. will not save after power down The second part of LED: 0: Setting freq. is to keep when stopping 1: Setting freq. will save in F0.2 when stopping 2: Setting freq. is clear when stopping The third and fourth part of LED(form right to left): Reserved	1	0000	
	F0.4	Operation channel selection	The first part of LED (form right to left): 0: Panel control 1: External terminals control 2: RS485 interface The second part of LED: Function of key STOP 0: It is valid for panel control. 1: It is valid for all kinds of control method. The third and fourth part of LED(form right to left): Reserved	1	0000	
	F0.5	Combination methods of instruction terminals	0: Two-line mode 1 1: Two-line mode 2 2: Three-line mode	1	0	★
	F0.6	Running direction control and setting of operation instruction auxiliary	The first part of LED (form right to left): 0: Running direction is consistent with setting direction 1: Running direction is in contradiction to setting direction The second part of LED: 0: Prevention REV is valid 1: Prevention REV is invalid The third and fourth part of LED(form right to left): External operation channel auxiliary function 0: self-starting is forbidden when inverter is just power-on 1: self-starting is allowed when inverter is just power-on The fourth part of LED(form right to left): Reserved	1	0100	
	F0.7	The lower limit frequency	0.0 Hz~ [F0.8]	0.01	0.0	
	F0.8	The upper limit frequency	[F0.7] ~ 400.00Hz	0.01	50.00	
	F0.9	Reserved				
	F0.10	Acc time 1	0.1 ~ 6000 s/min	0.1	▲	
F0.11	Dec time 1	0.1 ~ 6000 s/min	0.1	▲		

Function	Code	Name	Setting range	Minimum Setting	Manufactur Setting	Modify Limit
Basic operation parameter unit	F0.12	Characteristics parameter of Acc and Dec	The first part of LED (form right to left): 0: Beeline 1: S curve The second part of LED: 0: Output freq. will be modified according to Acc/Dec time. 1: Output freq. will be automatically modified according to lode. The third part of LED: Unit of Acc/Dec time 0: Sec 1: Min The fourth part of LED: Reserved	1	0000	
	F0.13	Acc/Dec initial section proportion Of S curve	10.0~ 50.0 (%)	0.1	20.0%	★
	F0.14	Acc/Dec ascending/decline section proportion of S curve	10.0 ~ 80.0 (%)	0.1	60.0%	★
	F0.15	Lode pattern selection	0: General-purpose lode. 1: Fan and pump lode.	1	0	★
	F0.16	Carrier wave frequency	1.5~ 10.0 KHZ	0.1	▲	
	F0.17	Carrier wave characteristics	The first part of LED (form right to left): Reserved The second part of LED: 0: Load carrier wave adjustment is invalid 1: Load carrier wave adjustment is valid The third part of LED: 0: Heat carrier wave adjustment is invalid 1: Heat carrier wave adjustment is valid The fourth part of LED: 0: Freq. relating carrier wave adjustment is Invalid 1: Freq. relating carrier wave adjustment is valid	1	1110	
	F0.18	Parameter write-protection	1: Forbid to modify all parameter, except F0.2 and F0.18 2: Forbid to modify all parameter, except F0.18	1	0	
Primary applied parameter unit	F1.0	Type of V/F Curve	0: Constant torque curve 1: Low-freq. torque curve 1 2: Low-freq. torque curve 2 3: V/F user-defined curve	1	0	★
	F1.1	Torque Boost	0.0~20.0 (%)	0.1	▲	
	F1.2	Torque boost pattern	0: Manual 1: Automatic	1	0	★
	F1.3	Basic running frequency	5.00~the upper limit frequency	0.01	50.00	
	F1.4	Max output voltage	200~500V 100~250V	1	380 220	
	F1.5	V/F freq. 3	[F1.7] ~ [F1.3]	0.01	0.0	★
	F1.6	V/F voltage 3	[F1.8] ~ 100.0(%)	0.1	0.0	★
	F1.7	V/F freq. 2	[F1.9] ~ [F1.5]	0.01	0.0	★
	F1.8	V/F voltage 2	[F1.10] ~ [F1.6]	0.1	0.0	★
	F1.9	V/F freq. 1	0.0 ~ [F1.7]	0.01	0.0	★
	F1.10	V/F voltage 1	[F1.1] ~ [F1.8]	0.1	0.0	★
	F1.11	DC braking current when starting	0.0 ~ 100.0 (%)	0.1	50.0	
	F1.12	DC braking time when starting	0.0 ~ 20.0s	0.1	0	★
	F1.13	Compensation for slipping freq.	0~150 (%)	1	0	
	F1.14	Droop control	0~100 (%)	1	0	
	F1.15	Initial level of droop control	0~150 (%)	1	25	
	F1.16	Ending level of droop control	10~200 (%)	1	100	
	F1.17	Droop control mode	0: Absolute droop 1: Relative droop	1	1	
F1.18	Reserved					

Function	Code	Name	Setting range	Minimum Setting	Manufactur Setting	Modify Limit	
Analog I/O parameter unit	F2.0	VC1 input lower limit voltage	0.0 V ~ [F2.1]	0.1	0.0V		
	F2.1	VC1 input upper limit voltage	[F2.0] ~ 5.0V	0.1	5.0 V		
	F2.2	VC2 input lower limit voltage	0.0V ~ [F2.3]	0.1	0.0 V		
	F2.3	VC2 input upper limit voltage	[F2.2] ~ 10.0V	0.1	10.0V		
	F2.4	CC input lower limit voltage	0.0mA~ [F2.5]	0.1	4.0mA		
	F2.5	CC input upper limit voltage	[F2.4] ~ 20.0mA	0.1	200 mA		
	F2.6	The min pulse input	0.0KHz~[F2.7]	0.01	0.0		
	F2.7	The max pulse input	[F2.6]~50.0 KHz	0.01	10.0KHz		
	F2.8	Frequency with the min setting	0.0~[F2.9] Hz	0.01	0.00Hz		
	F2.9	Frequency with the max setting	[F2.8]~300.0Hz	0.01	50.00Hz		
	F2.10	Characteristics selection of input channel	The first part of LED (form right to left) : (VC1channel) 0: positive characteristics 1: Negative characteristics The second part of LED: (VC2 channel) 0: positive characteristics 1: Negative characteristics The third part of LED: (CC channel) 0: positive characteristics 1: Negative characteristics The fourth part of LED: (pulse channel) 0: positive characteristics 1: Negative characteristics		1	0000	★
	F2.11	External freq. set time constant of filtering	0.01~1.00s	0.01	0.10		
	F2.12	Combination setting mode	Refer to the explanations about F2.12		1	0	
	F2.13	Analog output selection (AO1、AO2)	The first part of LED (form right to left): AO1output 0: Output freq. 1: Output current 2:Output voltage 3: Rotate speed of applied motor 4: PID setteng 5: PID feedback The second part of LED: AO2 output 0: Output freq. 1: Output current 2: Output voltage 3: Rotate speed of applied motor 4: PID setting 5: PID feedback The third and fourth part of LED: Reserved		1	0010	
	F2.14	The lower limit of analog output AO1	0.0 V / 0.0mA~[F2.15]	0.1	0.0 V		
	F2.15	The upper limit of analog output AO1	[F2.14]~12.0 V / 24.0mA	0.1	10.0V		
	F2.16	The lower limit of analog output AO2	0.0V / 0.0mA ~ [F2.17]	0.1	2.0 V		
	F2.17	The upper limit of analog output AO2	[F2.16] ~ 12.0V / 24.0mA	0.1	12.0V		
F2.18	Reserved						

Function	Code	Name	Setting range	Minimum Setting	Manufacture Setting	Modify Limit	
Digital O/I parameter unit	F3.0	Function selection of input terminal 1 (0~26)	0: Control terminal is idle 1: Multi-speed control terminal 1 2: Multi-speed control terminal 2 3: Multi-speed control terminal 3 4: Wobble freq. is valid 5: State of wobble freq. reset 6: FWD jog control 7: REV jog control 8: Acc& Dec time selection terminal 1 9: Acc& Dec time selection terminal 2 10: Freq. setting channel selection 1 11: Freq. setting channel selection 2 12: Freq. setting channel selection 3 13: Freq. is controlled gradually increase (UP) 14: Freq. is controlled gradually decrease (DW) 15: UP-DW freq. clear 16: Uncontrolled stop control 17: Fault signal of peripheral equipment input 18: Three-line mode running control 19: DC braking control 20: Inner counter clear 21: Inner counter timer 22: PLC running valid 23: PID running valid 24: Internal timer trigger terminal 25: PLC state reset after stopping 26: Multi-speed control terminal 4	1	1		
	F3.1	Function selection of input terminal 2 (0~26)		1	2		
	F3.2	Function selection of input terminal 3 (0~26)		1	3		
	F3.3	Function selection of input terminal 4 (0~26)		1	6		
	F3.4	Function selection of input terminal 5 (0~26)		1	13		
	F3.5	Function selection of input terminal 6 (0~26)		1	14		
	F3.6	Output terminal OC1		0: In the running 1: Frequency reaching 2: Freq. level detection signal (FDT) 3: Over-loading alarm 4: External fault halt 5: Output frequency reaches the upper-limit 6: Output frequency reaches the lower-limit 7: Running in zero speed 8: Internal timer reaches the setting time 9: PLC stage is end of run 10: PLC periodic is end of run 11: Internal timer arrive regular time 12: Setting value of counter arrives 13: Designated value of counter arrives 14: Deceleration running 15: Reserved 16: Inverter fault 17: Restrictions on wobble freq. of the upper and lower limit freq. 18: Reserved	1	2	
	F3.7	Output terminal OC2			1	1	
	F3.8	TA, TB and TC of relay contacts			1	16	
	F3.9	Frequency reach the checkout amplitude		0.0~20.00Hz	0.01	5.00	
	F3.10	FDT setting 1		0.0~the upper limit freq.	0.01	10.00	
	F3.11	FDT output delay time 1		0.0~200.0s	0.1	2.0	★
	F3.12	FDT setting 2		0.0~the upper limit freq.	0.01	10.00	
	F3.13	FDT output delay time 2		0.0~200.0s	0.1	2.0	★
	F3.14	Over-loading alarm level		50~200 (%)	1	110	
	F3.15	Over-loading alarm delay time		0.0~20.0s	0.1	2.0	★
F3.16	Reserved						

Function	Code	Name	Setting range	Minimum Setting	Manufactur Setting	Modify Limit
Auxiliary running parameter unit	F4.0	Start mode	0: Routine mode 1: Detect speed and restart	1	0	★
	F4.1	Start frequency	0.0~10.00Hz	0.01	0.5	
	F4.2	Start frequency duration	0.0~20.0s	0.1	0.0	★
	F4.3	Stop mode	0: Decelerate mode 1: Uncontrolled stop	1	0	
	F4.4	Initial freq. of DC braking when stopping	0.0~50.00Hz	0.01	3.00	
	F4.5	Waiting time of DC braking when stopping	0.0~5.0s	0.1	0.0	
	F4.6	Action time of DC braking when stopping	0.0~20.0s	0.1	0	★
	F4.7	DC braking current when stopping	0.0~100 (%)	0.1	50.0	
	F4.8	Running threshold of zero freq.	0.0~100.00Hz	0.01	0.0	
	F4.9	Return different of zero freq.	0.0~50.00Hz	0.01	0.50	
	F4.10	FWD jog frequency	0.0~the upper limit freq.	0.01	10.00	
	F4.11	Acc torque level	110~200 (%)	1	165	
	F4.12	Motor over-lode protection coefficient	50~110 (%)	1	110	
	F4.13	Automatic voltage regulation (AVR)	0: Invalid 1: Dynamic valid 2: Static valid 3: Deceleration invalid	1	0	
	F4.14	Energy-saving running	0: Invalid 1: Valid	1	0	
	F4.15	Intensify of energy-saving running	30~90	1	60	★
	F4.16	Dead time of FWD&REV	0.0~5.0s	0.1	0.0	★
	F4.17	Acceleration time 2	0.1~6000s/min	0.1	▲	
	F4.18	Deceleration time 2	0.1~6000 s/min	0.1	▲	
	F4.19	Acceleration time 3	0.1~6000 s/min	0.1	▲	
	F4.20	Deceleration time 3	0.1~6000 s/min	0.1	▲	
	F4.21	Acc time 4/Jog Acc time	0.1~6000 s/min	0.1	▲	
	F4.22	Dec time 5/Jog Dec time	0.1~6000 s/min	0.1	▲	
	F4.23	Modified rated of UP/DW terminals	0.01~100.0Hz/Sec	0.01	10.00Hz	
	F4.24	Start voltage of dynamic braking	600~750V	1	700V	
	F4.25	Action ratio of dynamic braking	10~100 (%)	1	60%	
	F4.26	Restart after power down setting	The first part of LED: 0: Invalid 1: Valid The second part of LED: 0: Routine mode 1: Detect speed and restart mode The third and fourth part of LED: Reserved	1	0010	★
	F4.27	Waiting time of restart after power down	0.0~10.0s	0.1	0.5	★
F4.28	REV jog frequency	0.0~the upper limit freq.	0.01	10.00		



Function	Code	Name	Setting range	Minimum Setting	Manufacture Setting	Modify Limit
Multi-speed running parameter unit	F5.0	Multi-speed running mode	The first part of LED(form right to left): Simple PLC selection 0: Simple PLC is invalid. 1: Simple PLC is valid 2: Simple PLC is conditional valid The second part of LED: Simple PLC running mode selection 0: Single loop mode 1: Single loop and stop mode 2: Continuous loop mode 3: Continuous loop and stop mode 4: Keep the end value 5: Keep the end value and stop mode The third part of LED 0: Restart from the first stage freq. 1: Restart from running freq., which is saved before running is break 2: Restart from setting freq. when running is break. The fourth part of LED: PLC save state 0: Non-save after power off 1: Save after power off	1	0000	★
	F5.1	Multi-speed frequency 1	0.0 ~ the upper limit freq.	0.01	35.00	
	F5.2	Multi-speed frequency 2	0.0 ~ the upper limit freq.	0.01	15.00	
	F5.3	Multi-speed frequency 3	0.0 ~ the upper limit freq.	0.01	3.00	
	F5.4	Multi-speed frequency 4	0.0 ~ the upper limit freq.	0.01	20.00	
	F5.5	Multi-speed frequency 5	0.0 ~ the upper limit freq.	0.01	25.00	
	F5.6	Multi-speed frequency 6	0.0 ~ the upper limit freq.	0.01	30.00	
	F5.7	Multi-speed frequency 7	0.0 ~ the upper limit freq.	0.01	35.00	
	F5.8	Multi-speed frequency 8	0.0 ~ the upper limit freq.	0.01	40.00	
	F5.9	Multi-speed frequency 9	0.0 ~ the upper limit freq.	0.01	35.00	
	F5.10	Multi-speed frequency 10	0.0 ~ the upper limit freq.	0.01	15.00	
	F5.11	Multi-speed frequency 11	0.0 ~ the upper limit freq.	0.01	3.00	
	F5.12	Multi-speed frequency 12	0.0 ~ the upper limit freq.	0.01	20.00	
	F5.13	Multi-speed frequency 13	0.0 ~ the upper limit freq.	0.01	25.00	
	F5.14	Multi-speed frequency 14	0.0 ~ the upper limit freq.	0.01	30.00	
	F5.15	Multi-speed frequency 15	0.0 ~ the upper limit freq.	0.01	35.00	
	F5.16	Running time of Multi-speed 1	0.0~6000s	0.1	10.0	
	F5.17	Running time of Multi-speed 2	0.0~6000s	0.1	10.0	
	F5.18	Running time of Multi-speed 3	0.0~6000s	0.1	10.0	
	F5.19	Running time of Multi-speed 4	0.0~6000s	0.1	10.0	
	F5.20	Running time of Multi-speed 5	0.0~6000s	0.1	10.0	
	F5.21	Running time of Multi-speed 6	0.0~6000s	0.1	10.0	
	F5.22	Running time of Multi-speed 7	0.0~6000s	0.1	10.0	
	F5.23	Running time of Multi-speed 8	0.0~6000s	0.1	10.0	
	F5.24	Running direction of PLC multi-speed	The first part of LED(form right to left): 0: Stage 1 FWD            1: Stage 1 REV The second part of LED: 0: Stage 2 FWD            1: Stage 2 REV The third part of LED: 0: Stage 3 FWD            1: Stage 3 REV The fourth part of LED: 0: Stage 4 FWD            1: Stage 4 REV	1	0000	
	F5.25	Running direction of PLC multi-speed	The first part of LED(form right to left): 0: Stage 5 FWD            1: Stage 5 REV The second part of LED: 0: Stage 6 FWD            1: Stage 6 REV The third part of LED: 0: Stage 7 FWD            1: Stage 7 REV The fourth part of LED: 0: Stage 8 FWD            1: Stage 8 REV	1	0000	
F5.26	PLC timing running shutdown	0: Invalid 1~9999(min) : timing running time	1	0		

Function	Code	Name	Setting range	Minimum Setting	Manufactur Setting	Modify Limit
Advanced running parameter unit	F6.0	Internal timer	0.1~6000.0s	0.1	10.0	
	F6.1	Fault self-recovery time	0, 1, 2	1	0	★
	F6.2	Interval time of fault self-recovery	0.2~20s	0.1	2.0	★
	F6.3	Final value setup of internal counter	1~60000	1	1	★
	F6.4	Internal timer setup	1~60000	1	1	★
	F6.5	Skip freq. 1	0.0~the upper limit freq.	0.01	0	
	F6.6	Amplitude accumulation of Skip freq. 1	0.0~5.00Hz	0.01	0	
	F6.7	Skip freq. 2	0.0~the upper limit freq.	0.01	0	
	F6.8	Amplitude accumulation of Skip freq. 2	0.0~5.00Hz	0.01	0	
	F6.9	Linear speed coefficient setting	0.01~100.0	0.01	1.00	
	F6.10	Close-loop analog coefficient setting	0.01~100.0	0.01	1.00	
	F6.11	Rotator speed coefficient setting	0.01~10.00	0.01	1.00	
	F6.12	Monitor item selection 1 / Main display	0~11	1	0	
	F6.13	Monitor item selection 2 / Auxiliary display	0~11	1	1	
	F6.14	Query or modify parameters	0 ~ 9999	1	1700	
	F6.15	Parameter initialization	0: Parameter initialization is off. 1: Parameter initialization is on. 2: Clean fault records 3: complete initialization	1	0	★
	F6.16	Copy parameter function	0: Copy forbidden 1: Copy allowed	1	0	
	F6.17	Manufactory password	0~9999	1	1500	
	F6.18	User password	0~9999	1	0	
F6.19	Reference password	0 ~ 9999	1	▲		
Wobble freq. running parameter unit	F7.0	Wobble freq. running mode	The first part of LED (form right to left) : 0: Function of wobble freq. is invalid. 1: Function of wobble freq. is valid. 2: Function of wobble freq. is conditional valid. The second part of LED: restart mode 0: Restart according to parameters saved before stop 1: Restart The third part of LED: wobble freq. characteristics 0: The wobble freq. is fixed 1: The wobble freq. is changeable. The fourth part of LED: Storage characteristics of wobble freq. 0: It will not save the running state of wobble freq. after power off 1: It will save the running state of wobble freq. after power off	1	1000	★
	F7.1	Preset freq. of wobble freq.	0.0 ~ the upper limit freq.	0.01	10.00	
	F7.2	Waiting time of preset freq.	0.0~6000.0s	0.1	0.0	★
	F7.3	Amplitude of wobble freq.	0.0~50.0 (%)	0.1	10.0	
	F7.4	Jumping freq.	0.0~80.0 (%)	0.1	10.0	
	F7.5	Triangular rise time	0.1~1000.0s	0.1	10.0	
	F7.6	Triangular fall time	0.1~1000.0s	0.1	10.0	
	F7.7	Preset center freq. of wobble freq.	0.0 ~ the upper limit freq.	0.01	10.0	
	F7.8	Reserved				

Function	Code	Name	Setting range	Minimum Setting	Manufactur Setting	Modify Limit
PID control parameter unit	F8.0	Inner PID control	The first part of LED(form right to left): Inner PID control 0: Inner PID control is invalid 1: Inner PID control is valid 2: Inner PID control is conditional valid. The second part of LED: PID controller selection 0: proportion 1: Integral 2: Proportion and integral The third part of LED: Regulating property of PID controller 0: positive interaction 1: Reactor The fourth part of LED: 0: Single polar PID control 1: Bi-polar PID control	1	0020	★
	F8.1	Inner PID setting and channel selection	The first part of LED(form right to left): 0: Digital setting. It is set by parameter F8.2. 1: Serials interface setting 2: Panel potentiometer setting, it is on the operation panel. 3: External voltage signal VC1 (0V~5V)。 4: External voltage signal VC2 (0V~10V)。 5: External current signal CC (0~20mA)。 The second part of LED: Reserved. The third part of LED: It is used to set PID feedback channel. 0: External voltage input VC1 1: External voltage input VC2 2: External current input CC 3: Pulse input PLS 4: VC1+CC 5: VC1-CC 6: Min (VC1, CC) 7: Max (VC1, CC) . The fourth part of LED: Reserved.	1	0000	★
	F8.2	Inner PID close-loop digital setting	0.00~10.00V	0.01	0.00	
	F8.3	Minimum fixed value	0.0~[F8.4]	0.01	0.0	
	F8.4	Maximum fixed value	[F8.3]~10.00	0.01	10.00	
	F8.5	Feedback of minimum fixed value	0.0~10.00	0.01	0.0	
	F8.6	Feedback of maximum fixed value	0.0~10.00	0.01	10.00	
	F8.7	Proportion gain	0.0~5.00	0.01	1.00	
	F8.8	Integral time constant	1.0~100.0s	0.1	10.0	
	F8.9	Allowable deviation limit	0.0~20.0 (%)	0.1	5.0	
	F8.10	Preset freq. for close-loop	0.0~the upper limit freq.	0.01	0.0	
	F8.11	Holding time of preset freq. for close-loop	0.0~6000.0s	0.1	0.0	★
	F8.12	Long-distance manometer range	0.001~20.000Mpa	0.001	1.000	
	F8.13	Sleeping threshold	[F8.14]~[F8.12]	0.001	1.000	
	F8.14	Awakening threshold	0.0~[F8.13]	0.001	0.0	
	F8.15	Switching time of Sleeping/Awakening mode	5.0~500.0 Sec	0.1	300.0	
	F8.16	Upper limit pressure value	[F8.16]~[F8.12] Mpa	0.001	1.000	
	F8.17	Lower limit pressure value	0.001 ~ [F8.15] Mpa	0.001	0.0	
	F8.18 ~ F8.24	Reserved				

Function	Code	Name	Setting range	Minimum Setting	Manufacture Setting	Modify Limit
Serials communication parameters	F9.0	Communication setting	The first part of LED(form right to left): It is used to set baud rate of serials communication. 0: Reserved 1: 1200bps 2: 2400bps 3: 4800bps 4: 9600bps 5: 19200bps The second part of LED: To set data format of serials communication. 0: Close 1: Even 2: Odd The third and fourth part of LED: Reserved.	1	0014	★
	F9.1	Local address	0~30	1	0	
	F9.2	Response delay of local	0~1000ms	1	5ms	
	F9.3	Function setting of communication Auxiliary function	The first part of LED(form right to left): 0: The inverter is guest 1: The inverter is host The second part of LED: Act selection after communication is lost 0: Stop 1: Keep The third part of LED: linkage jog 0: jog synchronized 1: jog asynchronous The fourth part of LED: linkage control synchronized frequency source 0: setting frequency 1: output frequency	1	0010	
	F9.4	Checkout time of communication overtime	0.0~100.0s	0.1	10.0	
	F9.5	Linkage setting proportion	0.010~10.000	0.01	1.000	
	F9.6	Rectify channel of linkage setting proportion	0: close 1: Panel potentiometer Rectify channel 2: External voltage signal VC1 (0 ~ 5V) Rectify channel 3: External voltage signal VC2 (0 ~ 10V) Rectify channel 4: External current signal CC (0 ~ 20mA)	1	0	
	F9.7	Setting channel of slave machine auxiliary freq.	0: no auxiliary freq. 1: Panel potentiometer 2: External voltage signal VC1 (0 ~ 5V) 3: External voltage signal VC2 (0 ~ 10V) 4: External current signal CC	1	0	
	F9.8	Amplitude of auxiliary freq.	0.0~25.00 Hz	0.01	5.00	
	F9.9	Load self-equilibrium function	0: Invalid 1: Valid	1	0	
	F9.10	Load self- equilibrium proportion	0.50~2.00	0.01	1.00	
F9.11	Trimming range of load self-equilibrium freq.	0.0~5.00	0.01	2.00		
Special function parameter unit	FC.0	Under voltage protection level	360~460V	1	380	
	FC.1	Over voltage limit level	660~760V	1	720	
	FC.2	Current amplitude limiting level	150~200 (%)	1	190	
	FC.3	Reserved				
	FC.4					

Function	Code	Name	Setting range	Minimum Setting	Manufacture Setting	Modify Limit
Special function parameter unit	FC.5	Action function selection	the first part of LED(form right to left): Cooling fan control 0: Cooling fan run after inverter run. 1: Cooling fan will automatic run when inverter is power on. The second part of LED: Variable speed control of cooling fan 0: Invalid                    1: Valid Cooling fan always keep the max speed. The third part of LED: Voltage over modulation 0: Invalid                    1: Valid	1	0000	
	FC.6	Auxiliary function	the first part of LED(form right to left): Forbid modify parameters function 0: Invalid                    1: Valid The second part of LED: Input terminal effective level 0:Low level (terminals is connected) 1:High level (terminals is disconnected ) The third part of LED: Reserved The fourth part of LED: selection of rotate speed display proportion 0: the coefficient of rotate speed display is valid 1: the deceleration proportion is valid	1	0000	
	FC.7	Reserved				
	FC.8	Agency password	0 ~ 9999	1	100	
	FC.9/F C.10	Reserved				
	FC.11	Oscillatory inhibiting factor	0.0~10.00	0.01	0.00	
	FC.12	Reserved				
FC.13	Program version	1600~1699	1	▲		

## 6. DESCRIPTION OF SPECIFIC FUNCTIONS

(General parameter: [F0.0]=0000)

### 6.1 Basic operation parameter unit

F0.0 Choosing the running mode	Setting range: 0000 ~ 0001
--------------------------------	----------------------------

It is used for selecting the running mode of inverter. Inverter is able to switch between the mode of general running and mode of dedicated drawing machine through changing the setting of first part of LED. And the parameters list and soft function mode have been operated.

The first part of LED(form right to left):

0:General mode(General parameter is valid.)

1:Dedicated drawing machine mode(Drawing machine parameter is valid.)

If the setting of parameter has changed, there would be a process of initialization, meantime, it would be shifted to the corresponding parameter environment. Meanwhile, this parameter can not be initialized.



Please refer to the Seventh Chapter to use parameters.

The first part of LED(form right to left): Reserved

F0.1 Frequency input channel / mode selection	Setting range: 0 ~ 9
-----------------------------------------------	----------------------

It is used for selecting input channel of frequency instruction.

0: Frequency setting by operation panel

Frequency of inverter is set by parameter F0.2 as well as by the key  and  on the operation panel in normal monitor mode.

1: UP/DW Acc and Dec control

Running frequency is set by terminals UP and DW. And controlled terminals UP and DW can be selected by parameters [F3.0]~[F3.5]. When UP is on, the running frequency will increase. When UP is on, the running frequency will decrease. When UP and DW is on or off together with CM, running frequency will fix. The rate of modified frequency of terminals UP and DW is set by parameter F4.23.

2: RS485 interface

Through serial communication, it receives instruction of setting frequency from PC or the master.

3: Panel potentiometer

Running frequency can be set by potentiometer on the operation panel.

4: External voltage signal VC1

Running frequency is set by external voltage signal VC1. (VC1 is form 0.0 to 5.0V) Please set the VC1 referring to the parameters F2.0 and F2.1.

5: External voltage signal VC2

Running frequency is set by external voltage signal VC2. (VC2 is form 0.0 to 10.0V) Please set the VC2 referring to the parameters F2.2 and F2.3.

6: External current signal CC

Running frequency is set by external current signal CC. (CC is form 0.0 to 20.0mA) Please set the CC referring to the parameters F2.4 and F2.5.

7: External pulse signal

Running frequency is set by external pulse signal. (It is form 0.0 to 350.0KHz, and the amplitude accumulation is form 5 to 30V) Please set the pulse signal referring to the parameters F2.6 and F2.7.

8: Combination setting

Running frequency is set by linear combination of each channel, and combination mode is decided by parameter F02.12.



9: External terminals

External terminals set input channel of frequency. And it can be set by parameters F3.0~F3.5.

Freq. Setting terminal 3	Freq. Setting terminal 2	Freq. Setting terminal 1	Freq. Setting channel
0	0	0	Frequency setting by operation panel
0	0	1	UP/DW Acc and Dec control
0	1	0	RS485 interface
0	1	1	Panel potentiometer
1	0	0	External voltage signal VC1
1	0	1	External voltage signal VC2
1	1	0	External current signal CC
1	1	1	External pulse signal

#### F0.2 Frequency digital setting

Setting range: 0.0 ~ the upper limit frequency

When F0.1 is 0, Frequency digital setting controls output frequency of inverter. In normal monitor state, user can use the key  and  to modify this parameter.

As for F0.1 is 1 or F0.1 is 2, the frequency will save in parameter F0.3 after power off, if F0.3 is 00#0.

#### F0.3 Auxiliary control of freq. digital setting

Setting range: 0000 ~ 0021

It is used for making sure that the frequency is set under the stopping or power off situation. When F0.1 is 0, 1 or 2, set parameter F0.3 to ensure that setting freq. is or not be saved in F0.2.

The first part of LED(form right to left):

0: Inverter will run in setting freq. that is storage in F0.2 after stopping

1: Setting freq. will lost after stopping. And inverter will run in 0.0Hz when restarting

The second part of LED(form right to left):

0: Setting freq. is kept when stopping

1: Setting freq. will save in F0.2 when stopping

2: Setting freq. is cleared when stopping

The third and fourth part of LED(form right to left): Reserved.





#### F0.4 Operation channel selection

Setting range: 0000 ~ 0012

It is used for selecting operation channel of inverter and function of key .

The first part of LED (form right to left): to select operation channel of inverter.

0: Keypad control

The inverter is controlled by key , ,  and  on the keypad. And FWD state will affect output phase sequence of inverter. When FWD is on with CM, output phase sequence will reverse with setting sequence, contrariwise, output phase sequence will go the same way with setting sequence.

1: External terminals control

The inverter receives running instruction form external terminals FWD, REV and CM. The manufacture setting is shown as follows.

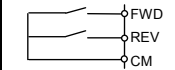
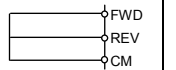
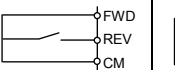
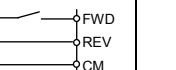
Instruction	Stop instruction		FWD	REV
Terminals State				

2: RS485 interface

Through serial communication, it receives instruction of setting frequency from PC or the master.

The second part of LED (form right to left): to select function of the key .

0: It is valid for panel control.

When F0.4 is 0, Stop key on the operation panel is available.

1: It is valid for all kinds of control method.

When F0.4 is not 0 and press  stop key, inverter will emergency stop and twinkling display Fu.16.

The third and fourth part of LED(form right to left): Reserved.

**F0.5 Combination methods of instruction terminals      Setting range: 0 ~ 2**

It is used for setting control mode of external terminals.



This parameter will be valid only when F0.4 is set as # # # 1

0: Two-line mode 1 (default setting)

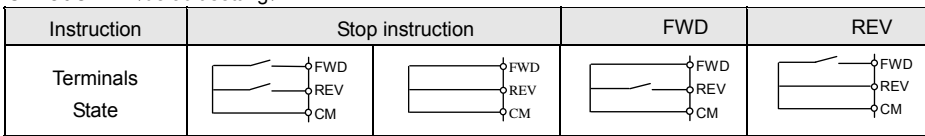

0: Two-line mode 2

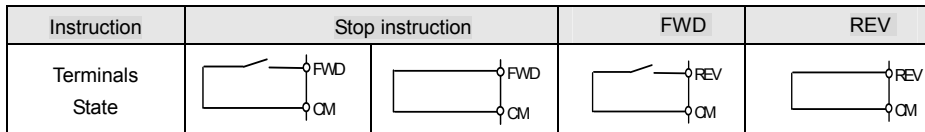

2: Three-line mode

Please select a three-line mode terminal to set three-line mode. (Refer to description of parameters F3.0 ~ F3.5) X? is three-line mode terminals, and it is any one among terminals X1 ~ X6.

Switch function is shown as follow:

1. SW1 — Stop trigger switch of inverter
2. SW2 — FWD trigger switch
3. SW3 — REV trigger switch

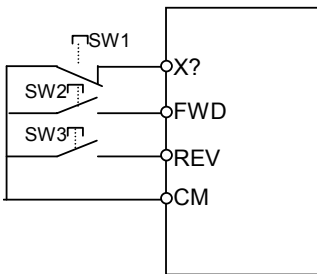

Fig.6-1 three-line mode wiring

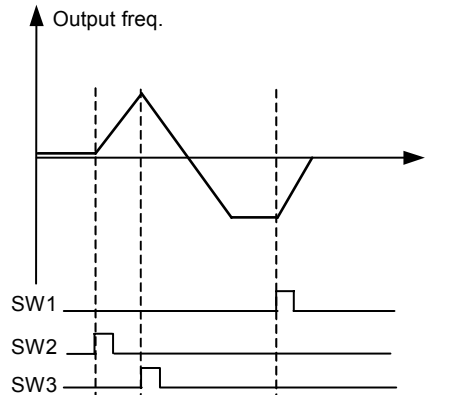

Fig.6-2 output freq. when three-line

**F0.6 Running direction control and instruction auxiliary setting      Setting range: 0000 ~ 0111**

It is used for changing the output phase-sequence of inverter, which changes the operating direction of motor (set by binary system).

The third part of LED: External operation channel auxiliary function

0: Self-starting is forbidden when inverter is just power-on



1: Self-starting is allowed when inverter is just power-on

When [F0.6]=#0##, when inverter is just power-on, even though the control terminal is in running, the inverter will not self-starting. In order to operate inverter, you should first give a stop signal, then a start-up instruction.

This parameter is used for modifying the present output phase sequence of inverter, which modifies the running motor direction. Control effect of panel control method is shown as following table.



Parameter F0.4 is valid together with direction control of external terminals.

FWD-CM	[F0.6]	Direction
OFF	##1#	FWD
ON	##1#	FWD
OFF	##00	FWD
OFF	##01	REV
ON	##00	REV
ON	##01	FWD

F0.7 The lower limit frequency

Setting range: 0.0 ~ [F0.8] Hz

F0.8 The upper limit frequency

Setting range: [F0.7] ~600.00Hz

When setting freq. is lower than lower limit freq., the inverter will run in lower limit freq. But the parameters F4.8 and F4.9 are priority over F0.7 and F0.8.

F0.9 Reserved

F0.10 Acc time 1

Setting range: 0.1 ~ 6000 Sec/Min

F0.11 Dec time 1

Setting range: 0.1 ~ 6000 Sec/Min

Acc time 1 is the time of output frequency accelerating from 0.0 Hz to 50.00Hz.

Dec time 1 is the time of output frequency decelerating from 50.00 Hz to 0.00Hz.

Units of Acc and Dec are set by parameter F0.12.

F0.12 character parameter of Acc and Dec

Setting range: 0000 ~ 0111

The first part of LED(form right to left): It is used for setting curve type when inverter is accelerating or decelerating, shown as fig6-3.

0: Beeline

Output freq. of inverter will increase or decrease according to fixed rated.

1: S curve

Output freq. of inverter will increase or decrease according to graded rated. Characteristic of S curve is set by parameter F0.13 and F0.14.

The second part of LED: To set Acc/Dec method

0: Output freq. will be modified according to Acc/Dec time.

1: Output freq. will be automatically modified according to load.

The third part of LED:

It is used for setting unit of Acc/Dec time, namely unit of parameters F0.10, F0.11, F4.17, F4.18, F4.19, F4.20, F4.21 and F4.22.

0: Sec.

The fourth part of LED: Reserved.

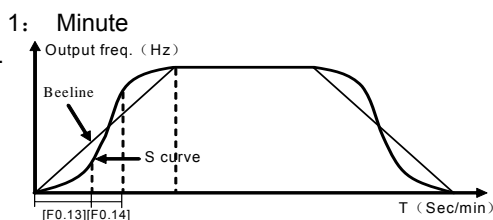

Fig.6-3 Acc/Dec curve

F0.13	Acc/Dec initial section proportion of S curve	Setting range: 10.0 ~ 50.0(%)
F0.14	Acc/Dec ascending/decline section proportion of S curve	Setting range: 10.0 ~ 80.0(%)

Parameters F0.13 and F0.14 define characteristic of S curve. It is totally divide into three sections, shown as fig6-3.

Acc/Dec initial section is process that slope of output freq. is gradual increase form 0. The slope will fix in Acc/Dec ascending/decline section. And the slope will gradual decrease to 0 in end section.

F0.15	Load pattern selection	Setting range: 0, 1
-------	------------------------	---------------------

0: General purpose load.

1: Fan and pump load.

F0.16	Carrier wave frequency	Setting range: 1.5 ~ 10.0 KHz
-------	------------------------	-------------------------------

Carrier wave frequency influences audio-frequency noise and calorific effect in running.

When environmental temperature is too high and motor's load is too heavy, carrier frequency should be decreased properly to improve the heat thermal performance.

F0.17	Carrier wave characteristics	Setting range: 0000 ~ 1110
-------	------------------------------	----------------------------

It is used for setting correlated characteristics about carrier wave.

The first part of LED (form right to left): Reserved

The second part of LED: Load relating carrier wave adjustment.

If this function is valid, when load current is too high, it will automatically reduce the carrier frequency to ensure operation safety of inverter.

0: Invalid      1: Valid

The third part of LED: Heat relating carrier wave adjustment

If this function is valid, when environmental temperature is too high, the inverter will automatically reduce the carrier wave frequency.

0: Invalid      1: Valid

The fourth part of LED: Freq. relating carrier wave adjustment

If this function is valid, the inverter will automatically reduce the carrier frequency in low-frequency running.

0: Invalid      1: Valid

Attention: When the inverter automatically adjusts carrier freq., the running noise will increase.

F0.18	Parameter write-protect	Setting range: 1, 2
-------	-------------------------	---------------------

It is used for preventing error modify about data.

1: Forbid to modify all parameter, except F0.2 and F0.18

2: Forbid to modify all parameter, except F0.18



In running, some parameters cannot be modified. At this time, if try to modify these parameters, the inverter will display "— —", please turn off the inverter before modify those parameters.

## 6.2 Primary application of parameter unit

F1.0	Type of V/F Curve	Setting range : 0 ~ 3
------	-------------------	-----------------------

### 0: Constant torque curve

The output voltage of inverter is in direct ratio to the output frequency, and most load take this mode.

### 1: low-freq. torque curve 1

The output voltage of inverter is conic with the output frequency, which is suited to the fan and pump load.

### 2: low-freq. torque curve 2

The output voltage of inverter is conic with the output frequency, which is suited to the constant power load, such as fan, pump, etc. If there is some unstable phenomenon in light-load running, please switch to run in the decreasing torque curve 1.

### 3: V/F user-defined curve

It is used for setting user-defined curve which user need.

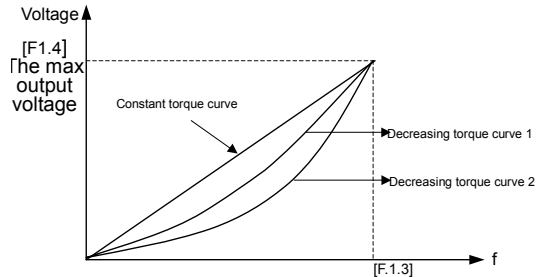
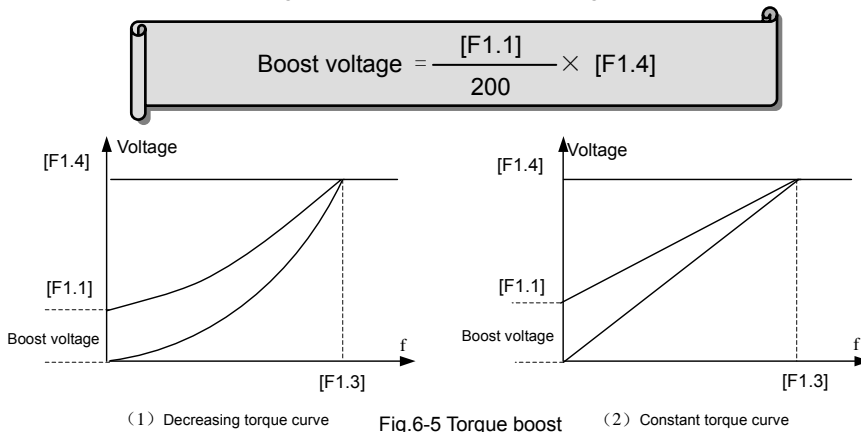

Fig. 6-4 V/F curve

F1.1 Torque Boost(output voltage at 0 Hz)

Setting range: 0.0 ~ 20.0 (%)

It is used for improving the low-frequency torque character. In low-frequency running, it will make boost compensation for the output voltage of inverter, as shown in Fig.6-5.



F1.2 Torque boost pattern

Setting range: 0 , 1

### 0: Manual

Torque boost voltage is completely controlled by F1.1. There are two features: voltage will steady boost. And motor will easily magnetic saturation when light-load.

### 1: Automatic

Torque boost voltage is changed with the stator current of motor. The boost voltage is higher with the stator current higher.

$$\text{Boost voltage} = \frac{[\text{F1.1}]}{200} \times [\text{F1.4}] \times \frac{\text{Inverter's output Current}}{2 \times \text{inverter's rated current}}$$

Auto torque boost can prevent the magnetic saturation, as the boost voltage is too high with light load, which can avoid the over-heat phenomenon of motor in low frequency running.

F1.3 Base running frequency	Setting range: 5.00 ~ the upper frequency
F1.4 Max output voltage	Setting range: 200 ~ 500V/100~250V

Basic running frequency is corresponding to minimum frequency when output voltage of inverter is the highest. Usually, it is rated frequency of motor.

Max output voltage is corresponding to output voltage when inverter outputs the basic running frequency. Usually, it is rated voltage of motor.

F1.5 V/F freq. 3	Setting range: F1.7] ~ [F1.3]
F1.6 V/F voltage 3	Setting range: [F1.8] ~ 100%
F1.7 V/F freq. 2	Setting range: [F1.9] ~ [F1.5]
F1.8 V/F voltage 2	Setting range: [F1.10] ~ [F1.6]
F1.9 V/F freq. 1	Setting range: 0.0 ~ [F1.7]
F1.10 V/F voltage 1	Setting range: [F1.1] ~ [F1.8]

Those parameters are used for setting user-defined curve which user need. Shown as Fig.6-6 below:

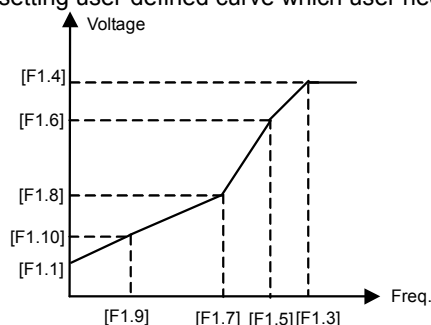

Fig.6-6 V/Fuser-defined curve

F1.11 DC braking current when starting	Setting range: 0.0 ~ 100.0 (%)
F1.12 DC braking time when starting	Setting range: 0.0 ~ 20.0 S

Those parameters are fit for the occasion that inverter needs brake before start.

$$F1.11 = \frac{\text{DC braking current when starting}}{\text{Rated current of inverter}} \times 100\%$$



When rated current of motor is lower than rated current of inverter, please pay attention to set F1.11. Make sure that DC braking current is lower than rated current of motor.

Parameter F1.12 defines duration that inverter output DC braking current. When F1.12 is 0, DC braking is invalid when starting.

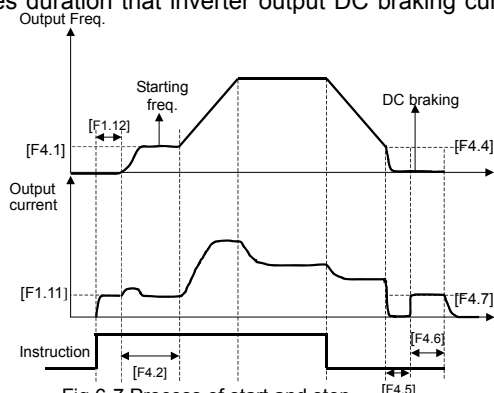

Fig.6-7 Process of start and stop

F1.13 Compensate for slip freq.	Setting range: 0.0 ~ 150 (%)
---------------------------------	------------------------------

The inverter will modify output freq. automatically to offset effects that is act on rotate speed of motor form load.

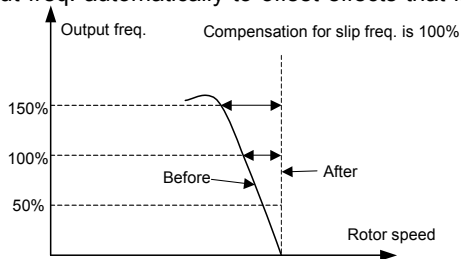

Fig.6-8 Compensate for slip freq.

F1.14 Droop control	Setting range: 0 ~ 100%
F1.15 Initial level of droop control	Setting range: 0 ~ 150%
F1.16 Ending level of droop control	Setting range: 10 ~ 200%

Droop control is a special control mode to poise output power when multi-inverters inverter the same load or rotator speed of motor will change with the load. It will poise power and torque by setting those parameters, when multi-inverters inverter the same load. If those parameters are appropriate set, applied asynchronous motor will have the same characteristic with torque motor. Shown as fig6-9.

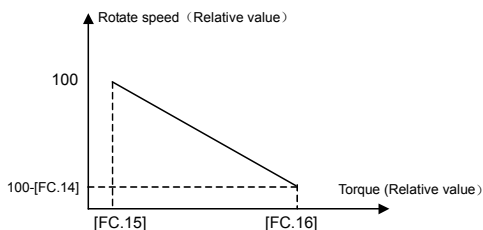

Fig6-9 Motor characteristic when droop control

They are nameplate parameters of applied motor. The running performance will improve if those parameters are input correctly.

F1.17 Droop control mode	Setting range: 0, 1
--------------------------	---------------------

Droop control is a special control mode that is used for poising output power when multi-inverters inverter the same load. Output power will decrease automatically when output torque or current of a certain inverter is heavier than usual. Some load will off, so the power will be poised.

The adjustment range of frequency changed with the load will decide by parameters FC.14, FC.15 and FC.16.

0: Absolute droop

$$\text{Actual output freq. of inverter} = \text{Setting freq.} - \frac{\text{Actual output torque level} - \text{initial level of droop}}{\text{Ending level of droop} - \text{Initial level of droop}} \times \text{Base running frequency [F1.3]}$$

The max of actual freq. of inverter is setting freq..

When setting freq. of inverter is lower than base-running freq., ending level of inverter will reduce to 0 before inverter run to ending level of droop.

1: Relative droop

$$\text{Actual output freq. of inverter} = \text{Setting freq.} - \frac{\text{Actual output torque level} - \text{initial level of droop}}{\text{Ending level of droop} - \text{Initial level of droop}} \times \text{Setting frequency}$$

The max of actual freq. of inverter is setting freq..

If output torque is beyond initial level of droop, output freq. will decrease. When output torque arrives ending level of droop, actual output freq. will reduce to 0.

F1.18	Reserved
-------	----------

### 6.3 Analog I/O parameter unit

F2.0	VC1 input lower limit voltage	Setting range:	0.0 V ~ [F2.1]
F2.1	VC1 input upper limit voltage	Setting range:	[F2.0] ~ 5.0 V

F2.2	VC2 input lower limit voltage	Setting range:	0V ~ [F2.3]
F2.3	VC2 input upper limit voltage	Setting range:	[F2.2] ~ 10.0V

F2.4	CC input lower limit voltage	Setting range:	0.0 mA ~ [F2.5]
F2.5	CC input upper limit voltage	Setting range:	[F2.4] ~ 20.0 mA

F2.6	the min pulse input	Setting range: :	0.0 KHz ~ [F2.7]
F2.7	the max pulse input	Setting range:	[F2.6] ~ 50.0 KHz

[F2.0] and [F2.1] define the range of analog input voltage channel VC1, and it should be set according to the actual input signal.

[F2.2] and [F2.3] define the range of analog input voltage channel VC2, and it should be set according to the actual input signal.

[F2.4] and [F2.5] define the range of analog input current channel CC, and it should be set according to the actual input signal.

[F2.6] and [F2.7] define the freq. range of external pulse signal.

F2.8	frequency with the min setting	Setting range:	0.0Hz ~ [F2.9]
F2.9	frequency with the max setting	Setting range:	[F2.8] ~ 600.0Hz

They define the Corresponding relation between analog input (pulse input) and setting frequency. Shown as fig.6-10.

F2.10	Character selection of input channel	Setting channel:	0000 ~ 1111
-------	--------------------------------------	------------------	-------------

It is used for selecting input character of external analog value or pulse value.

The first part of LED (form right to left):It defines character of voltage signal analog input VC1.

0: positive character                      1: Negative character

The second part of LED (form right to left): It defines character of voltage signal analog input VC2.

0: positive character                      1: Negative character

The third part of LED (form right to left): It defines character of current signal analog input CC.

0: positive character                      1: Negative character

The fourth part of LED (form right to left): It defines character of pulse signal analog input PLS.

0: positive character                      1: Negative character

The corresponding relation is shown as fig.6-10 between input signal and setting freq.

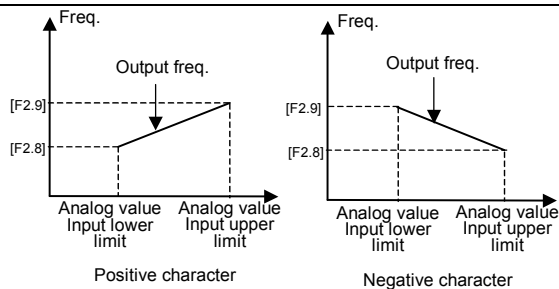

Fig.6-10 Corresponding relation between analog input and setting freq.

F2.11 External freq. set time constant of filtering	Setting range: 0.01 ~ 1.00s
-----------------------------------------------------	-----------------------------

Setting freq. set by external analog input will be filtered to eliminate fluctuation. Time constant of filtering have to appropriate set according to fluctuate of external input signal.

F2.12 Combination setting mode	Setting range: 0 ~ 29
--------------------------------	-----------------------

The parameter is valid only when the frequency input channel F0.1 is set as 8.

Setting Value	Combination setting mode	Setting Value	Combination setting mode
0	External voltageVC1 + External current CC	1	External voltageVC1 - External current CC
2	External voltageVC2 + External current CC	3	External voltageVC2 - External current CC
4	External voltageVC1 + External voltageVC2	5	External voltageVC1 - External voltage VC2
6	External voltageVC1 + pulse setting	7	External voltageVC1 - pulse setting
8	External voltageVC2+ External current CC+ pulse setting	9	External voltageVC2+ External current CC- pulse setting
10	External voltageVC1 + panel setting + pulse setting	11	External voltageVC1+ panel setting - pulse setting
12	External voltage1 + panel setting + digital setting	13	External voltage1 - panel setting + digital setting
14	External voltage2 + panel setting + digital setting	15	External voltage2 - panel setting + digital setting
16	External current + panel setting + digital setting	17	External current - panel setting + digital setting
18	Serials interface setting + External voltage1	19	Serials interface setting - External voltage1
20	Serials interface setting + External current + pulse setting	21	Serials interface setting - External current + pulse setting
22	Serials interface setting + External voltage1 + panel setting	23	Serials interface setting + External voltage2 - panel setting
24	External voltage2 + External current + panel setting	25	External voltage2+ External current - panel setting + digital setting
26	The max of external voltage1 and external voltage2	27	The max among External voltage1, External voltage2 and External current
28	Nonzero valid of External voltage1and External voltage2	29	Nonzero valid External voltage1, External voltage2 and External current CC

F2.13 Analog output selection	Setting range: 0000 ~ 0055
-------------------------------	----------------------------

It defines meaning of AO1、AO2.

The first part of LED: it defines the meaning of analog output terminal AO1.

The second part of LED: it defines the meaning of analog output terminal AO2.

0: Output freq.

Amplitude accumulation of AO1 and AO2 are in direct ratio to the output frequency. F2.15 and F2.17 are corresponding to the upper limit freq.

1: Output current

Amplitude accumulation of AO1 and AO2 are in direct ratio to the output current. F2.15 and F2.17 are twice rated current of inverter.

2: Output voltage

Amplitude accumulation of AO1 and AO2 are in direct ratio to the output voltage. F2.15 and F2.17 are corresponding to [F1.4] and [F1.14].

3: Rotate speed of applied motor

Amplitude accumulation of AO1 and AO2 are in direct ratio to the motor rotate speed of inverter. F2.15 and F2.17 are corresponding rotate speed that is corresponded the upper limit freq..

4: PID setting

Amplitude accumulation of AO1 and AO2 are in direct ratio to the setting value of PID. F2.15 and F2.17 are corresponding to feedback of 10.00.

5: PID feedback

Amplitude accumulation of AO1 and AO2 are in direct ratio to the PID feedback. F2.15 and F2.17 are corresponding to feedback of 10.00.

The third and fourth part of LED: Reserved.

F2.14	the lower limit of analog output AO1	Setting range: 0.0 V/0.0mA ~ [F2.15]
F2.15	the upper limit of analog output AO1	Setting range: [F2.14] ~ 12.0 V/24.0mA
F2.16	the lower limit of analog output AO2	Setting range: 0.0 V/0.0 mA ~ [F2.17]
F2.17	the upper limit of analog output AO2	Setting range: [F2.16] ~ 12.0 V/24.0mA

Those parameters define the max and min value of analog output AO1 and AO2, shown as fig 6-11.

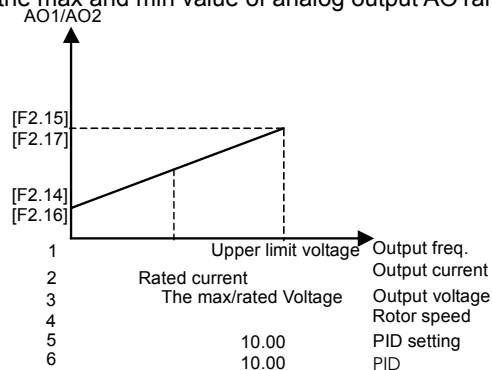
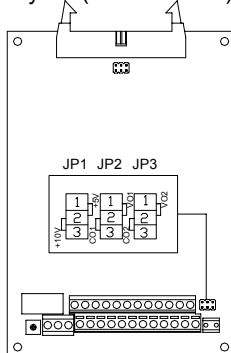

Fig.6-11 output of analog terminals

AO1 and AO2 provide voltage signal form 0 to 12V or current signal form 0 to 24 mA. Two kinds of output signal can be selected by JP (JP1 and JP2) switch. JP1 and JP2 are shown as fig.6-12.



JP2:  
 1-2 shorted: AO1 output voltage signal  
 2-3 shorted: AO1 output current signal  
 JP3:  
 1-2 shorted: AO2 output voltage signal  
 2-3 shorted: AO2 output voltage signal

Fig.6-12 JP2/JP3 terminals



F2. 18	Reserved
--------	----------

## 6.4 Digital O/I parameter unit

F3.0	Function selection of input terminal 1	Setting range: 0 ~ 26
F3.1	Function selection of input terminal 2	Setting range: 0 ~ 26
F3.2	Function selection of input terminal 3	Setting range: 0 ~ 26
F3.3	Function selection of input terminal 4	Setting range: 0 ~ 26
F3.4	Function selection of input terminal 5	Setting range: 0 ~ 26
F3.5	Function selection of input terminal 6	Setting range: 0 ~ 26

0: Control terminal is idle

1: Multi-speed control terminal 1

2: Multi-speed control terminal 2

3: Multi-speed control terminal 3

26: Multi-speed control terminal 4

Combination of multi-speed control terminals is used for selecting output freq. of multi-speed.

4: Wobble freq. is valid

When F7.0 is ###2 and any of those parameters is set 4, wobble freq. is valid.

5: State of wobble freq. reset

When inverter is stop and F7.0 is ##0#, forcible reset will work by setting those parameters.

6: FWD jog control

7: REV jog control

When F0.4 is ###1 and any of those parameters is set 6 or 7, external jog signal is valid.

8: Acc& Dec time selection terminal 1

9: Acc& Dec time selection terminal 2

They are used for selecting external terminals Acc/Dec time 1~4.

10: Freq. setting channel selection 1

11: Freq. setting channel selection 2

12: Freq. setting channel selection 3

When F0.1 is 9, Frequency input channel is set by terminals state of 10, 11 and 12. See the explanation about parameter F0.1.

13: Freq. is controlled gradually increase (UP)

14: Freq. is controlled gradually decrease (DW)

15: UP-DW freq. clear

When F0.3 is ##0#, one of terminal X1~X6 defined by this parameter have function of forcible clear.

16: Uncontrolled stop control

If one of terminal X1~X6 defined by this parameter is connected with CM, the inverter will lock output signal and applied motor will uncontrolled stop. Then inverter will detect speed and restart after terminal is disconnected with CM.

17: Fault signal of peripheral equipment input

When one of terminal X1~X6 is defined by this parameter is connected with CM, peripheral equipment is fault. The inverter will lock output signal and display FU.16.

18: Three-line mode running control

When F0.5 is 2, one of external terminal X1~X6 defined by this parameter is stop trigger switch of inverter. See explanation about F0.5.

19: DC braking control

When inverter stops and one of external terminals X1~X6 defined by this parameter is connected with CM and output freq. is lower than Initial freq. of DC braking, function of DC braking is valid until terminal is disconnected with CM. Refer to explanation about F4.4~F4.7.

20: Inner counter clear

21: Inner counter timer

Only terminal X6 is used for Inner timer, namely parameter F3.5 is 21.

22: PLC running valid

When F5.0 is ###2 and any of those parameters is set 22, PLC running is valid.

23: PID running valid

When F8.0 is ###2 and any of those parameters is set 23, PID running is valid. .

24: Internal timer trigger terminal

The terminals is defined to be the internal timer trigger terminal

25: PLC state reset after stopping

If F5.0 is set as #1##, the PLC state will keep fix. But external terminals will force reset, which is set by this function.

F3.6	Output terminal OC1	Setting range: 0 ~ 18
F3.7	Output terminal OC2	Setting range: 0 ~ 18
F3.8	TA, TB and TC of relay contacts	Setting range: 0 ~ 18

It defines expression content of relay contact and terminals OC1 and OC 2 when collector is open-circuit. Shown as fig.6-13. .

When TA is on with TC, setting functions will available.

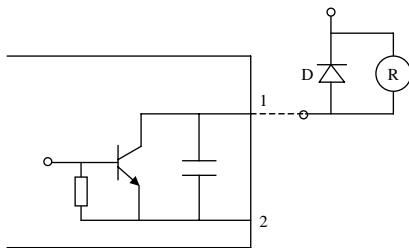

While connecting the external inductance cell (For example, Relay coil), it must connect the parallel fly-wheel diode D.

Fig.6-13 Inner wiring diagram of output terminals

## 0: In the running

When the inverter is in the running state, it will output the valid signal. While the inverter is in stop mode, it will output the invalid signal.

## 1: Frequency reaching

When the output frequency of inverter approaches the certain range of the setting frequency. (The range is decided by parameter F3.9), it outputs valid signal, otherwise, outputs the invalid signal (High-resistance).

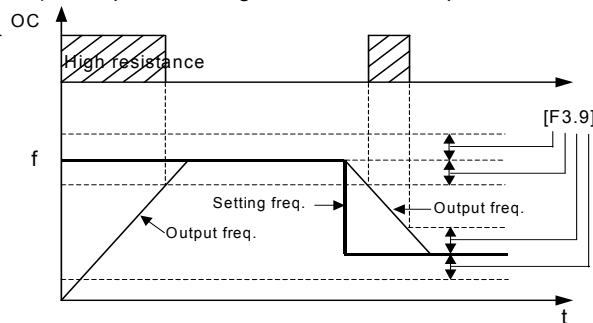

Fig.6-14 Freq. reaching signal

## 2: Freq. level detection signal (FDT)

When the output frequency of inverter is over FDT Frequency level, the inverter will output the valid signal (Low electrical level) after the setting delay time. When the output frequency of inverter is lower than FDT frequency level, after the same delay time, it will output the invalid signal (High resistance).

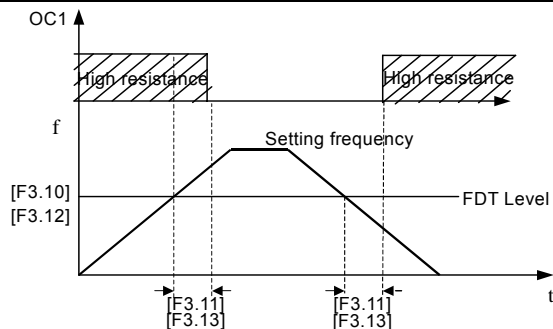

Fig. 6-15 Freq. level detection signal (FDT)

### 3: Over-loading alarm

When the output current of inverter is over the over-loading alarm level, it will output the valid signal (Low level) after the setting alarm delay time. When the output current is lower than the over-loading alarm level, it will output the invalid signal (High resistance) after the same delay time.

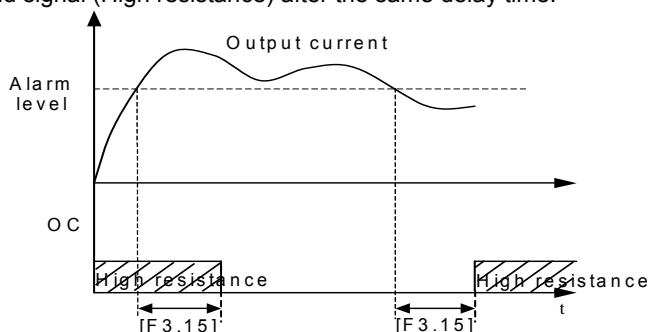

Fig.6-16 Over-load alarm

### 4: External fault halt

When the external fault input signal is valid and it will lead to stop-machine, the terminal will output the valid signal (Low level), otherwise it will output the invalid signal (High resistance).

### 5: Output frequency reaches the upper-limit

When the output frequency reaches the upper-limit frequency, the terminal will output the valid signal (Low level). Otherwise, it will output the invalid signal (High resistance).

### 6: Output frequency reaches the lower-limit

When the output frequency reaches the lower-limit frequency, the terminal will output the valid signal (Low level). Otherwise, it will output the invalid signal (High resistance)

### 7: Running in zero speed

Running instruction is valid and output freq. is 0, if inverter is input freq., the terminal will output the valid signal (Low electrical level). If inverter is not input freq., the terminal will output the invalid signal (High resistance).

### 8: Internal timer reaches the setting time

When the internal timer reaches the setting time, the terminal will output the valid pulse signal of 0.5 Sec pulse widths. (Low electrical level)

### 9: PLC stage is end of run

When simple PLC is valid and current stage is end, this port will output pulse signal with 0.5s pulse width.

### 10: PLC periodic is end of run

When simple PLC is valid and current period is end, this port will output pulse signal with 0.5s pulse width.

### 11: Internal timer arrive regular time

If the internal timer arrive regular time, the corresponding port will output 0.5s width pulse signal.

### 12: Setting value of counter arrives

See the explanation about parameter F6.3.

13: Designated value of counter arrives

See the explanation about parameter F6.4.

14: Deceleration running

15: Reserved

16: Inverter fault

When inverter is running with fault, it will output available signal (low level).

17: Restrictions on wobble freq. of the upper and lower limit freq.

When parameters setting about wobble freq. result in that running freq. is beyond the upper and lower limit freq., this port will output available signal (lower lever). Generally, this port output high resistance.

18: Reserved

F3.9	Frequency reach the checkout amplitude	Setting range: 0.0 ~ 20.00Hz
------	----------------------------------------	------------------------------

If output freq. of inverter is within setting value that is set by F3.9, selected terminal will output valid signal. Shown as fig.6-15.

F3.10	FDT setting 1	Setting range: 0.0 ~ upper limit freq.
F3.11	FDT output delay time 1	Setting range: 0.0 ~ 200.0 s
F3.12	FDT setting 2	Setting range: 0.0 ~ Setting range
F3.13	FDT output delay time 2	Setting range: 0.0 ~ 200.0 s

The parameter is used for setting the frequency detection level. When output frequency is higher than the setting value of FDT, after the setting delay time, terminals will output the valid signal, shown as fig.6-15.

Parameters F3.10 and F3.11 are used for setting FDT of OC1, parameters F3.12 and F3.13 are used for setting FDT of OC2.

F3.14	Overload alarm level	Setting range: 50 ~ 200 (%)
F3.15	Overload alarm delay time	Setting range: 0.0 ~ 20.0s

If output freq. beyond the setting value set by parameter F3.14, after the setting delay time set by parameter F3.15, terminals output valid signal, shown as fig.6-16.

F3.16	Reserved
-------	----------

## 6.5 Auxiliary running parameter unit

F4.0	Start mode	Setting range: 0~1
F4.1	Start frequency	Setting range: 0.0~10.00Hz
F4.2	Start frequency duration	Setting range: 0.0~20.0s

Those parameters are used for defining characteristic with relation to start mode, shown as fig6-17.

The explanation of F4.0 is shown as follows.

0: Routine mode

It is fit for mostly load, which have not special demand.

1: Detect speed and restart

It is fit for fault reset and restart occasion, or, power off and restart occasion. Inverter will judge automatically running speed and direction of motor. Motor, which have not stop, will start up directly according to detect result.

Start frequency : It is fit for system, which is big inertia, heavy load and high start torque.

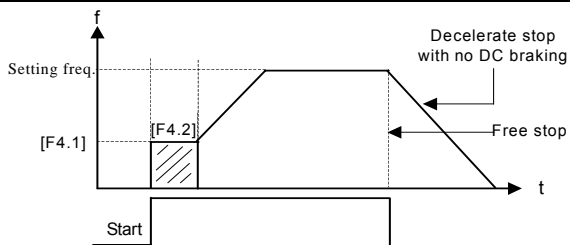

Fig6-17 Start and stop freq. output curve

F4.3 Stop mode

Setting range: 0 ~ 1

0: Decelerate mode

Inverter will gradually decrease output freq. to 0 according to Dec time when stopping.

1: Uncontrolled stop

Inverter will output zero freq. and lock output signal when stop, so motor will uncontrolled stop.

If user needs restart motor before motor complete stop, function of detect speed and restart must be valid when inverter is uncontrolled stop.

Start mode and stop mode is shown as fig6-16.

F4.4 Initial freq. of DC braking when stopping

Setting range: 0.00 ~ 50.00 Hz

F4.5 Waiting time of DC braking when stopping

Setting range: 0.0 ~ 5.0 S

F4.6 Action time of DC braking when stopping

Setting range: 0.0 ~ 20.0 S

F4.7 DC braking current when stopping

Setting range: 0.0 ~ 100 ( % )

It is used for setting DC braking parameters when stopping, shown as fig6-7.

When output freq. is lower than setting freq. of Parameter F4.4, inverter will lock output and start DC braking function after waiting setting time of parameter F4.5. DC braking when stopping is invalid while F4.6 is 0.

DC braking current when stopping is the percentage of rated current of inverter. When capability of applied motor is lower than inverter capability, please be sure to set F4.7.

F4.8 Running threshold of zero freq.

Setting range: 0.00 ~ 100.00 (Hz)

F4.9 Return different of zero freq.

Setting range: 0.00 ~ 50.00 (Hz)

Those parameters define characteristic of freq. zero-crossing.

When inverter takes analog input freq. to set freq., analog signal will fluctuate around zero to cause astable input. Those parameters have lagging function to avoid fluctuating around zero. Appropriate set Function of sleep and awakening will be work, if those parameters are appropriate set. For example analog input channel VC2 is shown as fig6-18.

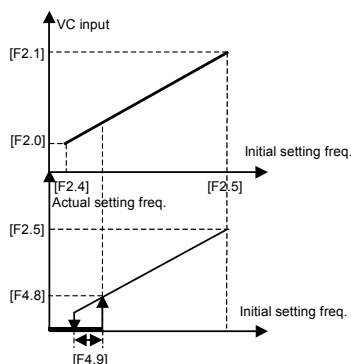

Fig6-18 freq. zero-crossing curve

F4.10 FWD jog frequency

Setting range: 0.0 ~ Upper limit

Jog running is special running method of inverter.

Whatever the initial state of inverter is stop or run, jog signal will be received. The transition from initial running freq. to jog freq. is ac8 according to parameters F4.21 and F4.22.

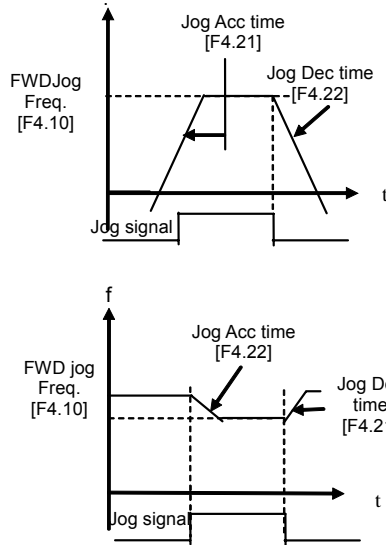

Fig6-19 Jog running

#### F4.11 Acc torque level

Setting range: 110 ~ 200 (%)

It is used for setting permissible output level of torque current under motor acceleration state.

The restriction on torque level is set by F4.11. It is percentage of rated current of inverter. For example, F4.11 set 150% that means the max output current is 150 percentage of rated current.

When output current of inverter is beyond setting value of F4.11, inverter will prolong Acc/Dec time to inhibit output current in setting value of F4.11. Shown as fig6-20.

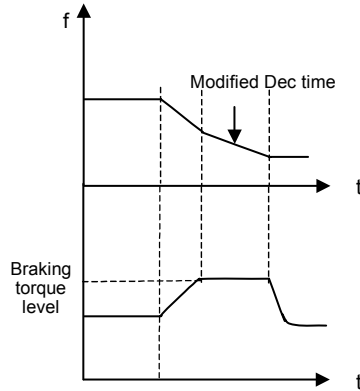

Fig6-20 Acc torque level

#### F4.12 Motor over-load protection coefficient

Setting range: 50 ~ 110 (%)

The parameter is used for setting the sensitivity of thermal relay protection for applied motor. When the rated current of applied motor doesn't match with the rated current of inverter, it can accomplish the correct heat protection for the motor to set this parameter.

The setting value of this parameter can be set by the following formula:

$$[F4.13]= \frac{\text{Rated current of motor}}{\text{Inverter's rated output current}} \times 100\%$$



While one inverter parallel running with multi-motors, the thermal relay protection of inverter will be invalid, in order to protect the motor, please install the thermal relay on inlet terminals the motor.

#### F4.13 Automatic voltage regulation (AVR)

Setting range: 0 ~ 3

The function of Automatic voltage regulation is to ensure the output voltage of inverter not to fluctuate with the input voltage. When the range of fluctuation of power supply voltage is too heavy, and expect to motor have the stabilized stator voltage and current, this function should be open.

0: Invalid      1: Dynamic valid      2: Static valid      3: Deceleration invalid

When user selects dynamic voltage regulation, fast dynamic voltage regulation can inhibit form increasing current cause by DC voltage in motor deceleration. But it easy brings current resonance.

In acceleration and stabilization state, automatic voltage regulation is valid; but in deceleration state, it is invalid.

#### F4.14 Energy-saving running

Setting range: 0 ~ 1

0: Valid

1: Invalid

When F4.15 is 0, inverter will check motor load automatically and real-time rectify output voltage.

Energy-saving running works high efficiency under occasions that the range of freq. is small and the range of speed is wide.

Because fan or pump has a specific relationship with rotation speed, it can compendiary judge load state according output freq.. Low-freq. torque curve V/F is a typical example in energy-saving running. When user takes low-freq. torque curve (F0.1 is 1 or2), function of energy-saving running needn't valid.

#### F4.15 Intensity of energy-saving running

Setting range: 30 ~ 90

It is used for setting the voltage regulating strength in energy-saving running. When inverter is in energy-saving running state, output voltage will be automatically adjusted with load, to enable the motor running in the most efficient state.

If the parameter is set larger, the energy-saving effect is better, and the running stability will be worse. The client can set the parameter according to currently state.

#### F4.16 Dead time of FWD&REV

Setting time: 0.0 ~ 5.0 Sec

The parameter means that the duration at zero frequency when the inverter changes its running direction, and it is shown as the following fig.6-21. FWD and REV dead time is set for the big inertia load which has the mechanical dead zone.

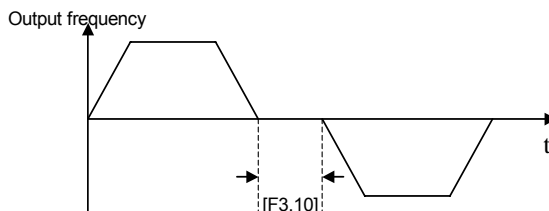

Fig.6-21 Dead zone between FWD and REV

F4.17 Acceleration time 2

Setting range: 0.1 ~ 6000 Sec

F4.18 Deceleration time 2

Setting range: 0.1 ~ 6000 Sec

F4.19 Acceleration time 3

Setting range: 0.1 ~ 6000 Sec

F4.20 Deceleration time 3

Setting range: 0.1 ~ 6000 Sec

F4.21 Acc time 4/Jog Acc time

Setting range: 0.1 ~ 6000Sec

F4.22 Dec time 5/Jog Dec time

Setting range: 0.1 ~ 6000Sec

**Jog frequency has the highest priority.** In any state, as long as Jog instruction is input, the inverter will transit to run at Jog frequency according to the setting Acc and Dec time.

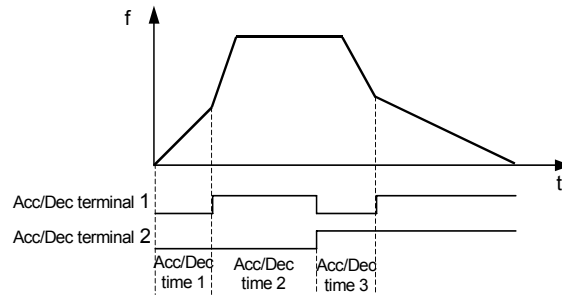

Fig.6-22 Acc/Dec time selection

F4.23 Modified rated of UP/DW terminals

Setting range: 0.01 ~ 100.00 (Hz/Sec)

It defines rate that terminals UP/DW modify setting freq. Speed of F4.23 isn't controlled by Acc/Dec time.

F4.24 Start voltage of dynamic braking

Setting range: 600 ~ 750 V

F4.25 Action ratio of dynamic braking

Setting range: 10 ~ 100 (%)

Those parameters are valid for inverter with the inner brake unit. And they define the action parameter of inner brake unit. When inner DC voltage of inverter is higher than the start voltage of dynamic braking, the inner brake unit will act. If inverter connects external brake resistance, DC energy of inverter will be release by it to decline DC voltage. When DC voltage declines to the certain value ( $[F4.24]-50V$ ), inner brake unit of inverter will be off, shown as Fig.6-23.

Brake unit action ratio is used for defining the voltage on brake resistor, and the voltage on brake unit is Voltage PWP. Duty cycle equals brake action ratio. The ratio is larger, and the energy is consumed more quickly, at the same time, the power of brake resistor is bigger. User can set parameter according to the resistance and power of resistor and actual brake effect.

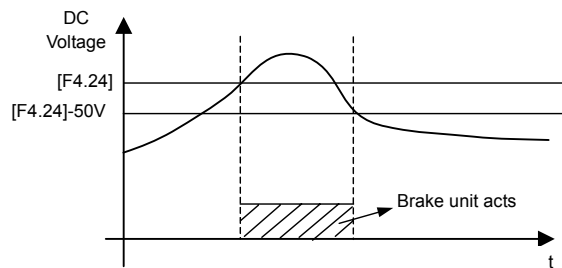

Fig.6-23 dynamic braking

F4.26 Restart after power down setting

Setting range: 0000 ~ 0011

F4.27 waiting time of restart after power down

Setting range: 0.0 ~ 10.0s

Parameter F4.26

The first part of LED:

0: Invalid                      1: Valid

When restart after power down setting is invalid, the inverter will clear automatically all running command and run according to new command after power on.

When restart after power down setting is valid, the inverter will save all running command and run according to the save command after power on.



Please make sure that other equipments in system are ready before using function of restart after power down.

The second part of LED:

Applied motor is still running when user select restart. Here, user have to select function of checking speed and restarting.

The third and fourth part of LED: reserved.

F4.28 REV jog frequency	Setting range: 0.0 ~ Upper limit
-------------------------	----------------------------------

## 6.6 Multi-speed running parameter unit

F5.0 Multi-speed running mode	Setting range: 0000 ~ 1252
-------------------------------	----------------------------

F5.1 Multi-speed frequency 1	Setting range: 0.0 ~ the upper limit freq.
------------------------------	--------------------------------------------

F5.2 Multi-speed frequency 2	Setting range: 0.0 ~ the upper limit freq.
------------------------------	--------------------------------------------

F5.3 Multi-speed frequency 3	Setting range: 0.0 ~ the upper limit freq.
------------------------------	--------------------------------------------

F5.4 Multi-speed frequency 4	Setting range: 0.0 ~ the upper limit freq.
------------------------------	--------------------------------------------

F5.5 Multi-speed frequency 5	Setting range: 0.0 ~ the upper limit freq.
------------------------------	--------------------------------------------

F5.6 Multi-speed frequency 6	Setting range: 0.0 ~ the upper limit freq.
------------------------------	--------------------------------------------

F5.7 Multi-speed frequency 7	Setting range: 0.0 ~ the upper limit freq.
------------------------------	--------------------------------------------

F5.8 Multi-speed frequency 8	Setting range: 0.0 ~ the upper limit freq.
------------------------------	--------------------------------------------

F5.9 Multi-speed frequency 9	Setting range: 0.0 ~ the upper limit freq.
------------------------------	--------------------------------------------

F5.10 Multi-speed frequency 10	Setting range: 0.0 ~ the upper limit freq.
--------------------------------	--------------------------------------------

F5.11 Multi-speed frequency 11	Setting range: 0.0 ~ the upper limit freq.
--------------------------------	--------------------------------------------

F5.12 Multi-speed frequency 12	Setting range: 0.0 ~ the upper limit freq.
--------------------------------	--------------------------------------------

F5.13 Multi-speed frequency 13	Setting range: 0.0 ~ the upper limit freq.
--------------------------------	--------------------------------------------

F5.14 Multi-speed frequency 14	Setting range: 0.0 ~ the upper limit freq.
--------------------------------	--------------------------------------------

F5.15 Multi-speed frequency 15	Setting range: 0.0 ~ the upper limit freq.
--------------------------------	--------------------------------------------

F5.16 Running time of Multi-speed1	Setting range: 0.0 ~ 6000s
------------------------------------	----------------------------

F5.17 Running time of Multi-speed2	Setting range: 0.0 ~ 6000s
------------------------------------	----------------------------

F5.18 Running time of Multi-speed3	Setting range: 0.0 ~ 6000s
------------------------------------	----------------------------

F5.19 Running time of Multi-speed4	Setting range: 0.0 ~ 6000s
------------------------------------	----------------------------

F5.20 Running time of Multi-speed5	Setting range: 0.0 ~ 6000s
------------------------------------	----------------------------

F5.21 Running time of Multi-speed6	Setting range: 0.0 ~ 6000s
------------------------------------	----------------------------

F5.22 Running time of Multi-speed7	Setting range: 0.0 ~ 6000s
------------------------------------	----------------------------

F5.23 Running time of Multi-speed8	Setting range: 0.0 ~ 6000s
------------------------------------	----------------------------

F5.24 Running direction of PLC multi-speed	Setting range: 0000 ~ 1111
--------------------------------------------	----------------------------

F5.25 Running direction of PLC multi-speed	Setting range: 0000 ~ 1111
--------------------------------------------	----------------------------

Parameter F5.0 is multi-speed running mode. It is used for setting basic characteristic of multi-speed running.

The first part of LED(form right to left): Simple PLC selection

0: Simple PLC is invalid.

1: Simple PLC is valid. If priority of freq. channel is permit after starting, inverter will run at simple PLC state.

2: Simple PLC is conditional valid. If external X1~X6 terminals is valid (F3.0~F3.5 is set as 22), inverter will run at simple PLC state.

Priority of freq. channel is shown as following table.

Priority		Setting freq.
High  Low	1	JOG freq.
	2	Wobble freq. running
	3	PID output
	4	PLC multi-speed freq.
	5	External terminals select multi-speed freq.
	6	Freq. setting channel selection (Parameter [F0.1] )

The second part of LED: Simple PLC running mode selection

#### 0: Single loop mode

The inverter will run in setting freq of the first stage and in turn output freq. of each stage according to setting running time. If setting running time of a certain stage is 0, the inverter will skip this stage. When a cycle operation is end of run, inverter will stop input until user input available running instrument to restart a next cycle.

#### 1: Single loop and stop mode

Its function has an analogy with single loop mode. The difference is that output freq. is be reduced to 0 within the given decelerate time after a certain stage is end of run and inverter will run next stage.

#### 2: Continuous loop mode

Inverter will run eight stages in turn. If the eighth stage is end of run, the inverter will run the next cycle form the first stage.

#### 3: Continuous loop and stop mode

Its function has an analogy with Continuous loop mode. The difference is that output freq. is be reduced to 0 within the given decelerate time after a certain stage is end of run and inverter will run next stage.

#### 4: Keep the end value

Its function has an analogy with single loop mode. The difference is that inverter will run in the last stage with non-zero speed.

#### 5: Keep the end value and stop mode

Its function has an analogy with keep the end value. The difference is that inverter will reduce the output freq. to 0 after arriving setting value of Acc time after a certain stage is end of run and, then inverter will run the next stage.

The third part of LED

#### 0: Restart from the first stage freq.

When inverter stop, caused by fault or receiving stop instrument in PLC running, it will clear current running state and restart form the first stage freq.

#### 1: Restart from running freq., which is saved before the running is breaking.

When inverter stop, caused by fault or receiving stop instrument in PLC running, inverter will restart from running time and freq. that is saved before the running is breaking.

#### 2: Restart from setting freq. when the running is breaking.

When inverter stop, caused by fault or receiving stop instrument in PLC running, setting of running time and freq. of a certain stage will be saved. And inverter will restart form setting of running time and freq. the different between mode 1 and mode 2 is initial freq.. Shown as fig6-24.

The fourth part of LED: PLC save state

#### 0: Non-save after power off

It will not be saved PLC running state after power off. Inverter will run form the stage 1 when power is on.

#### 1: Save after power off

It will save PLC running state after power off. Inverter will run form the stage 1 when power is on.

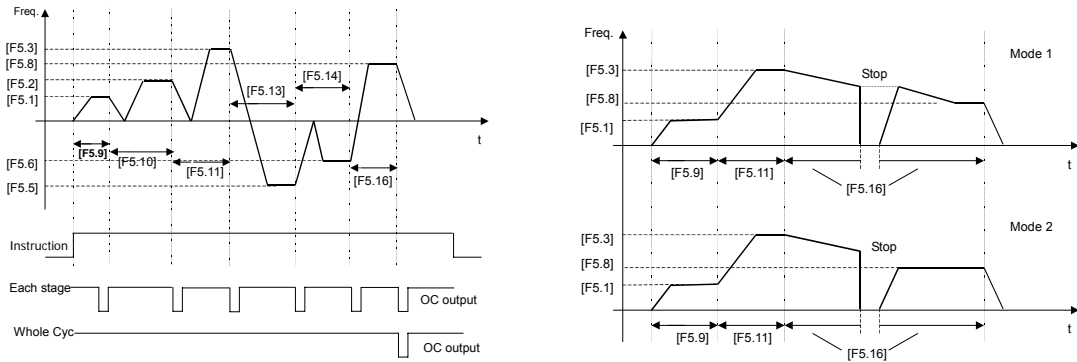

Fig.6-24 PLC recover running after restart

[F5.1]~[F5.15] Multi-speed freq.1~15

Those parameters are used for setting output freq. of multi-speed.

[F5.16]~[F5.23] Running time of Multi-speed 1~8

Those parameters are used for confirming running time of each stage.

[F5.24]、[F5.25] Running direction of PLC multi-speed

Those parameters are used for defining running direction of PLC multi-speed.

[F5. 24]

The first part of LED(form right to left):

0: Stage 1 FWD      1: Stage 1 REV

The second part of LED:

0: Stage 2 FWD      1: Stage 2 REV

The third part of LED:

0: Stage 3 FWD      1: Stage 3 REV

The fourth part of LED:

0: Stage 4 FWD      1: Stage 4 REV

[F5. 25] :

The first part of LED(form right to left):

0: Stage 5 FWD      1: Stage 5 REV

The second part of LED:

0: Stage 6 FWD      1: Stage 6 REV

The third part of LED:

0: Stage 7 FWD      1: Stage 7 REV

The fourth part of LED:

0: Stage 8 FWD      1: Stage 8 REV

F5.26 PLC timing running shutdown

Setting range: 0000~9999min

When PLC multi-speed running function is valid, it is used for setting PLC multi-speed running, beyond the time, it will automatically shutdown. To recovery operations, first give a shutdown instruction, and then give a start-up instruction. When the parameter equals 0, timing running shutdown function is invalid.

## 6.7 Advanced running parameter unit

F6.0 internal timer

Setting range: 0.1 ~ 6000.0 Sec

It is used for setting the internal timer. The internal timer is triggering start-up by external terminals X1~X6, external terminals X1~X6 should be set as 24(explained by parameters F3.0~F3.5). Internal timer arrives the regular time, OC1、OC2 or TA, TB, TC will output 0.5s width pulse (set by F3.6~F3.8).

The function can realize the timing operation shutdown.

F6.1	Fault self-recovery time	Setting range: 0 ~ 2
F6.2	Interval time of fault self-recovery	Setting range: 0.2 ~ 20.0s

F6.1 is used for resetting some faults and run again.

F6.2 defines interval time between fault starting and fault recovery. If inverter can't recover in setting value of F6.1, it will output fault signal. Inverter will check speed and restart.



Inverter can't self-recovery about overheat or overload protect.

F6.3	Final value setup of internal counter	Setting range: 1 ~ 60000
F6.4	Internal timer setup	Setting range: 1 ~ 60000

The parameter defines the counting action of internal counter, and the clock terminals of counter is selected by parameter F1.6.

The counting value of counter for the external clock reaches the value appointed by parameter F3.5, and the corresponding Terminal OC outputs a valid signal of same width with the external clock cycle.

When the counting value of counter for external clock reached the value appointed by Parameter F6.3, the corresponding Terminal OC will output the valid signal, Go on counting to the value provided by parameter F6.4, which will lead to reset and the output valid signal will be withdrawn.

The clock cycle of counter should be over 5ms and the min width should be 2ms.

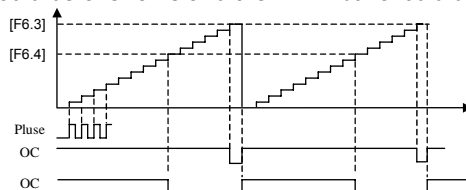

Fig.6-25 Internal counter function

F6.5	Skip freq. 1	Setting range: 0.0 ~ upper frequency
F6.6	Amplitude accumulation of Skip freq. 1	Setting range: 0.0 ~ 5.00Hz
F6.7	Skip freq.2	Setting range: 0.0 ~ upper frequency
F6.8	Amplitude accumulation of Skip freq. 2	Setting range: 0.0 ~ 5.00Hz

It is used for avoiding resonance point of mechanical load. Shown as fig. 6-26.

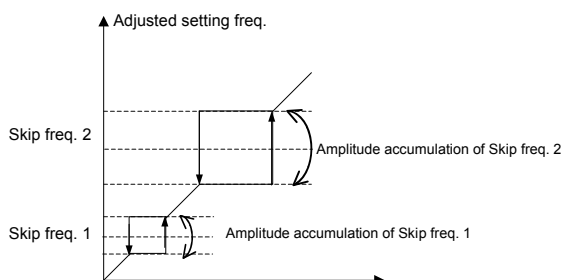

Fig.6-26 Skip freq.

F6.9 Linear speed coefficient setting

Setting range: 0.01 ~ 100.0

This parameter is used for confirming the display value of running linear speed and setting linear speed, and displaying other value being positive ratio with the output frequency.

$$\text{Running linear velocity (d-10)} = \text{F6.9} \times \text{output frequency (d-0)}$$

$$\text{Setting linear velocity (d-11)} = \text{F6.9} \times \text{Setting frequency (d-6)}$$

F6.10 close-loop analog coefficient setting

Setting range: 0.01 ~ 100.0

$$\text{PID feedback value (d.9)} = \text{F6.10} \times \text{actual feedback value}$$

$$\text{PID setting value (d.8)} = \text{F6.10} \times \text{setting value}$$

F6.11 rotator speed coefficient setting

Setting range: 0.01 ~ 10.00

It is used for rectifying the display value of rotator speed.

$$\text{rotator speed (d.3)} = \text{F6.11} \times \text{actual output rotator speed}$$

F6.12 Monitor item selection 1 / Main display

Setting range: 0 ~ 11

F6.13 Monitor item selection 2 / Auxiliary display

Setting range: 0 ~ 19

This parameter is used for confirming display content of operation panel in state monitor mode.

F6.14 Query or modify parameters

Setting range : 0 ~ 9999

It is used for getting check code to query or modify parameters.

F6.15 parameter initialization

Setting range: 0 ~ 3

It is used for modifying inverter's parameters to manufacture setting.

0: Parameter initialization is off.

1: Parameter initialization is on.

Parameter F0~F9 return to manufacture setting.

The following parameters can't be initialized:

[F0.0]: Reserved

[F0.1]: Frequency input channel / mode selection

[F0.4]: Operation channel selection

[F6.17]: Manufactory password

[F6.18]: User password

[F6.19]: Reference password

2: Clean fault records

3: Complete initialization

Except the following parameters, Parameters F0~FC return to manufacture setting and clean fault records.

[F0.0]: Reserved

[F6.17]: Manufactory password

[F6.19]: Reference password

[FC.3]: Reserved  
 [FC.4]: Reserved  
 [FC.8]: Agency password  
 [FC.13]: Program version

F6.16 Copy parameter function	Setting range: 0 ~ 1
-------------------------------	----------------------

0: Forbid

It is forbidden to copy the backup data form operation panel to inverter, but this function doesn't affect the copy and read parameter function.

1: Allow

F6.17 manufactory password	Setting range: 0 ~ 9999
----------------------------	-------------------------

Don't modify this parameter without our permission.

F6.18 user password	Setting range: 0 ~ 9999
---------------------	-------------------------

It is used for getting some special power for user.

F6.19 reference password	Setting range: 0 ~ 9999
--------------------------	-------------------------

It is always random number.

## 6.8 wobble freq. running parameter unit

F7.0 wobbles freq. running mode	Setting range: 0000~1112
---------------------------------	--------------------------

It is used for setting basic characteristic of wobble freq. running.

The first part of LED (form right to left) :

0: Function of wobble freq. is invalid.

1: Function of wobble freq. is valid.

When inverter receives running instruction, inverter will run in setting freq. of F7.1. Then inverter will in wobble freq. running mode after arriving setting time of F7.2.

2: Function of wobble freq. is conditional valid.

When external input terminals are valid (namely one of F3.0~F3.5 is 4), the inverter will run in wobble freq. running mode. When external input terminals are invalid, the inverter will run in preset freq. of wobble freq. (F7.1).

The second part of LED: restart mode

0: Restart according to parameters saved before stop                      1: Restart

The third part of LED: wobble freq. characteristic (See explanation about parameter F7.3)

0: The wobble freq. is fixed                      1: The wobble freq. is changeable.

The fourth part of LED: Storage characteristic of wobble freq.

0: It will not save the running state of wobble freq. after power off

1: It will save the running state of wobble freq. after power off

F7.1 Preset freq. of wobble freq.	Setting range: 0.0 ~ the upper limit freq.
F7.2 waiting time of preset freq.	Setting range: 0.0 ~ 6000.0s

Preset freq. of wobble freq. is running freq. before inverter is in or out wobble freq. mode.

When [F7.0]=###1, inverter will start and run in preset freq. of wobble freq., then run in wobble freq. mode after the setting time of F7.2.

When [F7.0]=###2 and the terminals of wobble freq. is valid (F3.0~F3.5 is 4), the inverter will run in wobble freq. mode. When [F7.0]=###2 and the terminals of wobble freq. is invalid, inverter will output preset freq. [F7.1].

## F7.3 Amplitude of wobble freq.

Setting range: 0 ~ 50.0 %

F7.3 is rate of amplitude of wobble freq.

When F7.0 is [F7.0]=#0##,

Amplitude of wobble freq. = [F7.3]×the upper limit freq. [F0.8]

When F7.0]=#1##,

Amplitude of wobble freq. = [F7.3]× (Preset center freq. of wobble freq. [F7.7] + External setting freq.)

## F7.4 Jumping freq.

Setting range: 0.0 ~ 80.0 %

When freq. arrives the upper limit freq. , the freq. will fast decline. Or when freq. arrives the lower limit freq., the freq. will fast ascend. Jumping freq. is amplitude, which freq. is ascend or decline. Shown as fig6-27.

Actual jumping freq. = [F7.4]×Amplitude of wobble freq. [F7.3]

## F7.5 Triangular rise time

Setting range: 0.1 ~ 1000.0 s

## F7.6 Triangular fall time

Setting range: 0.1 ~ 1000.0 s

F7.5 defines the running time form lower limit freq. to upper limit freq. of wobble freq., namely Acc time

F7.6 defines the running time form upper limit freq. to lower limit freq. of wobble freq., namely Dec time

The sum of F7.5 and F7.6 is running cycle of wobble freq.



F7.5 and F7.6 define slope of Acc and Dec in wobble freq.

## F7.7 Preset center freq. of wobble freq.

Setting range: 0.0 ~ upper limit freq.

Center freq. of wobble freq. is central value of output freq. when inverter is in wobble freq. mode. The sum of setting value of F7.7 and F0.1 is actual center freq.

Running process of wobble freq. is shown as fig6-28.

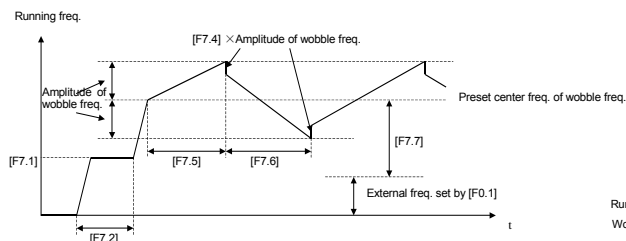
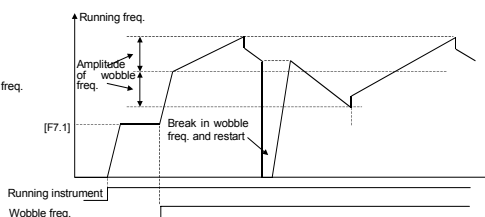

Fig.6-27 running process of wobble freq.



6-28Running process of wobble freq.

## F7.8 Reserved

## 6.9 PID control parameter unit

## F8.0 Inner PID control

Setting range: 0000 ~ 1122

The first part of LED(form right to left): Inner PID control

0: Inner PID control is invalid      1: Inner PID control is valid

2: Inner PID control is conditional valid. Inner PID is set by external terminals X1~X6 ( Parameters F3.0~F3.5) .

The second part of LED: PID controller selection

0: proportion      1: Integral      2: Proportion and integral

The third part of LED: Regulating property of PID controller

0: positive interaction                      1: Reactor

The fourth part of LED: reserved.

F8.1 inner PID setting and channel selection

Setting range: 0000 ~ 5705

It is used for setting inner PID and feedback channel.

The first part of LED(form right to left): It is used for setting PID channel .

0: Digital setting. It is set by parameter F8.2.

1: Serials interface setting

2: Panel potentiometer setting, it is on the operation panel.

3: External voltage signal VC1 (0V~5V)。

4: External voltage signal VC2 (0V~10V)。

5: External current signal CC (0~20mA)。

The second part of LED: Reserved.

The third part of LED: It is used for setting PID feedback channel.

0: External voltage input VC1 is as feedback channel, which is in the range of 0~5V.

1: External voltage input VC2 is as feedback channel, which is in the range of 0~10V.

2: External current input CC is as feedback channel, which is in the range of 0~20mA.

3: Pulse input PLS is as feedback channel, which is in the range of 0~50KHz.

4: VC1+CC Feedback value is composed of VC1 and CC.

5: VC1-CC Feedback value is that VC1 minus CC.

6: Min (VC1, CC) Feedback value is min value between VC1and CC.

7: Max (VC1, CC) Feedback value is max value between VC1and CC.

The fourth part of LED: Reserved.

F8.2 Inner PID close-loop digital setting

Setting range: 0.0 ~ 10.00V

If F8.1 is 0#00, setting value will be set by F8.2.

F8.3 Minimum fixed value

Setting range: 0.0 ~ [F8.4]

F8.4 Maximum fixed value

Setting range: [F8.3] ~ 10.00

F8.5 Feedback of minimum fixed value

Setting range: 0.0 ~ 10.00

F8.6 Feedback of maximum fixed value

Setting range: 0.0 ~ 10.00

Parameters F8.3 and F8.4 define the upper and lower limit value of PID setting. Parameters F8.5 and F8.6 define corresponding relation with PID feedback value. Shown as fig.6-29.

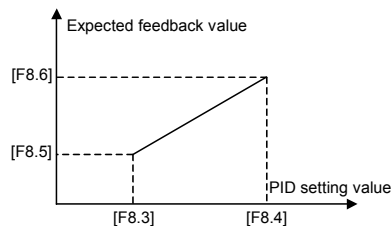

Fig.6-29 Relation between PID fixed value and expected feedback value

F8.7 Proportion gain

Setting range: 0.0 ~ 5.00

F8.8 Integral time constant

Setting range: 1.0 ~ 100 Sec

Those parameters are inner parameter of PID.



F8.9 Allowable deviation limit	Setting range: 0.0 ~ 20.0(%)
--------------------------------	------------------------------

The parameter is the allowable deviation value relative to the setting max value. When the difference between feedback value and the setting value is lower than this setting value, PID controller will stop. Shown as fig.6-30.

This function is mainly suited for the system that has lower control precision and needs to avoid adjusting frequently, for example, water-supply with constant pressure system.

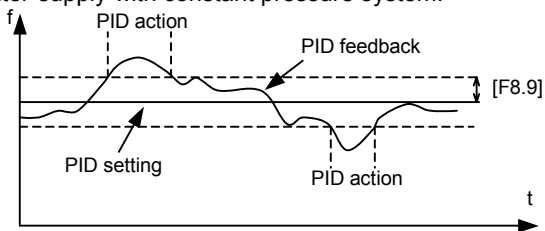

Fig.6-30 PID Control allowable deviation limit

F8.10 Preset freq. for close-loop	Setting range: 0.00 ~ the upper limit freq.
F8.11 Holding time of preset freq. for close-loop	Setting range: 0.0 ~ 6000.0s

Those parameters define freq. and running time of inverter before actual PID control is valid. In some control systems, inverters will forcible output a certain freq. (F8.10) and keep it in setting time (F8.11) for controlled object arrives fast targeted value. When controlled object almost arrives targeted value, PID controller will be valid to improve response speed.

F8.12 long-distance manometer range	Setting range: 0.00~20.000Mpa
-------------------------------------	-------------------------------

It defines measuring range of long-distance manometer, user have to input it.

F8.13 Sleeping threshold	Setting range: [F8.14]~[F8.12]
--------------------------	--------------------------------

It defines feedback value while inverter goes sleep state. When actual feedback value is larger than setting value and inverter arrives lower limit value, the inverter will go to sleep.

F8.14 Awakening threshold	Setting range: : 0.0~[F8.13]
---------------------------	------------------------------

It defines feedback value while inverter is in the state of sleeping. When actual feedback value is less than setting value, the inverter will be in the sleepy state. The inverter will wait [F8.15] to switch modes, if the inverter receives satisfied sleep or awakening condition. Shown as fig.6-31.

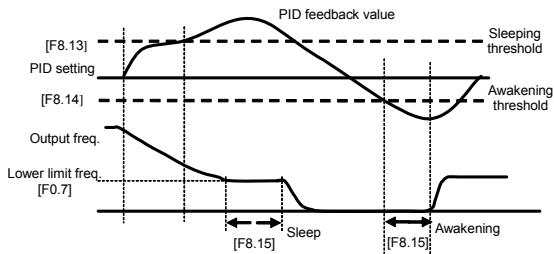

Fig.6-31 Sleep and awakening function of PID

F8.15 Switching time of Sleeping/Awakening mode	Setting range: : 5.0~500.0 s
-------------------------------------------------	------------------------------

When PID controller operates, switching time of sleeping/awakening mode is shown as fig.6-31.

F8.16	upper limit pressure value	Setting range: [F8.13]~[F8.12] Mpa
F8.17	Lower limit pressure value	Setting range: 0.001 ~ [F8.14] Mpa

It is used for setting the upper and lower limit pressure value.

F8.18~F8.24 Reserved
----------------------

## 6.10 Communication function parameter units

F9.0	Communication setting	Setting range: 0000 ~ 0025
------	-----------------------	----------------------------

The first part of LED(form right to left): It is used for setting baud rate of serials communication.

0: Reserved      1: 1200bps      2: 2400bps  
 3: 4800bps      4: 9600bps      5: 19200bps

To make sure both sides have the same baud rate, when client use serials communication.

The second part of LED: To set data format of serials communication.

0: Close      1: Even      2: Odd

To make sure both sides have the same data format, when client use serials communication.

The third and fourth part of LED: Reserved.

F9.1	Local address	Setting range: 0 ~ 30
------	---------------	-----------------------

F9.2	Response delay of local	Setting range: 0 ~ 1000 ms
------	-------------------------	----------------------------

It defines waiting time, which is the time form local receives correctly code to send response data frames.

F9.3	Function setting of communication Auxiliary function	Setting range: 0000 ~ 1111
------	------------------------------------------------------	----------------------------

The first part of LED(form right to left):

0: The inverter is slave  
 1: The inverter is master

The second part of LED: Act selection after communication is lost

0: Stop      1: Keep

The third part of LED: Linkage jog

0: Jog synchronized  
 1: Jog asynchronous

The fourth part of LED: Linkage control synchronized frequency source

0: Setting frequency  
 1: Output frequency

F9.4	Checkout time of communication overtime	Setting range: 0.0 ~ 100.0 Sec
------	-----------------------------------------	--------------------------------

If the machine itself dosen't receive correct data signals in regulate time, the communication is fault. Inverter will keep on running or stop according to setting of parameter F9.3.

F9.5	linkage setting proportion	Setting range: 0.010 ~ 10.000
F9.6	Rectify channel of linkage setting proportion	Setting range: 0 ~ 4

It is used for setting proportion of output freq. between master and slave, when takes linkage setting control.

When F9.6 is 0, rectify channel of linkage setting proportion is invalid.

Slave freq. = Master freq. × [F9.5]

When F9.6 is 1, 2, 3 or 4, rectify channel of linkage setting proportion is valid. When the lower limit value of rectify channel is selected, The rectify coefficient is 0.5; when the upper limit value of rectify channel is selected, the rectify coefficient is 2.0 ,

Slave freq. = Master freq. × [F9.5] × rectify coefficient (0.50~2.00)

F9.6 is used for selecting rectify channel.

Rectify channel 1: Panel potentiometer

Rectify channel 2: External voltage signal VC1 (0 ~ 5V)

Rectify channel 3: External voltage signal VC2 (0 ~ 10V)

Rectify channel 4: External current signal CC (0 ~ 20mA)

F9.7 Setting channel of guest inverter auxiliary freq.

Setting range: 0~4

F9.8 Amplitude of auxiliary freq.

Setting range: 0.0~25.00 Hz

It is used for selecting the setting channel of guest inverter auxiliary freq. and amplitude of auxiliary freq.

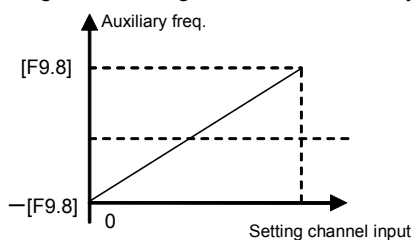

Fig.6-32 Adjust amplitude of auxiliary freq.

When the input value of auxiliary freq. setting channel is middle value, auxiliary freq. is 0, Slave output freq. = master instruction freq. × linkage proportion + auxiliary freq. (Linkage proportion is set by [F9.5], [F9.6])

F9.9 Load self- equilibrium function

Setting range: 0~1

F9.10 Load self- equilibrium proportion

Setting range: 0.50~2.00

F9.11 Trimming range of load self- equilibrium freq

Setting range: 0.0~5.00

These parameters are used for setting load self-equilibrium function , in linkage synchronous running mode, master inverter is equals an inverter plus a high-precision synchronizer, usually can get high-precision freq. synchronous.

In some application field, load of inverter group should keep balanced so that all the transmission chain tension or velocity strict agreement.

AE2 serial of inverter has loaded self- equilibrium function when inverters are in linkage running mode. When the load self- equilibrium function is valid, master inverter will transfer the load information to every slave inverter, and every slave inverter will adjust the load instructions according the master.

When the certain slave inverter should to bear a heavier load, it could change through [F9.10]. The value is greater, the load capacity is heavier.

Load self- equilibrium below 5Hz, the effect limited. Only if each master and slave inverter has good linkage ratio coefficient, the self- equilibrium function is valid.

If the adjust is not obvious, please increase parameter [F9.11].

## 6.11 Special function parameter unit

FC.0 Under voltage protection level

Setting range: 360V ~ 460V

It defines lower limit voltage which terminals P+ and P- are allow while inverter is working normally. For some low voltage conditions, user can decrease under voltage protection level to ensure that inverter is running normally.

FC.1 over voltage limit level

Setting range: 660V ~ 760V

It defines threshold of voltage stall protection while motor is decelerating. If DC voltage caused by decelerating is beyond setting value of FC.1, deceleration time will automatic prolong. Shown as fig6-33.

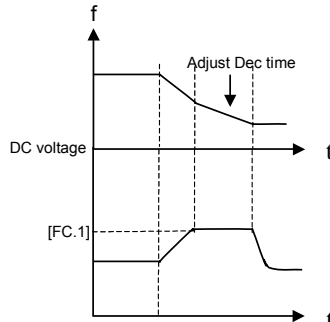

Fig.6-33 Voltage stall protection in Dec

FC.2 current amplitude limiting level

Setting range: 150 ~ 200%

It defines the max output current which is permitted by inverter. Whatever the operation mode is, inverter will adjust output freq. to inhibit current within the range of regulation, when output current of inverter is beyond setting value of FC.2.

FC.3 Reserved

FC.4 Reserved

It is used for setting some coefficients with special function in running process. Generally, user needn't set.

The first part of LED(form right to left): Under voltage compensation intensity

The second part of LED: Over voltage inhibit intensity

The third part of LED: Over current inhibit intensity

The fourth part of LED: Self-adapting braking torque adjust intensity

FC.5 Action function selection

Setting range: 0000 ~ 0111

The first part of LED(form right to left): Cooling fan control

0: Cooling fan run after inverter run.

Cooling fan will stop after inverter stop. When temperature is above 40°C, the cooling fan also will also run.

1: Cooling fan will automatic run when inverter is power on.

The second part of LED: Reserved.

The third part of LED: Voltage over modulation

0: Invalid 1: Valid

The fourth part of LED: Reserved.

FC.6 Auxiliary functions

Setting range: 0000~0011

The first part of LED(form right to left): Forbid to modify parameter.

0: Invalid.

1: Valid.

When it forbids modifying parameter is valid, [F0.18] will be invalid, if you want to get new password, please

ask for our service department. This function is used for preventing modify parameter wrongly.

The second part of LED: Input terminal effective level .

0: Low level (terminals is connected)

1: High level (terminals is disconnected)

The third part of LED: Reserved

The fourth part of LED: Selection of rotate speed display proportion

0: the coefficient of rotational speed display is valid

Rotational speed display=Rotational speed  $\times$  Rotator speed coefficient setting(F6.11)

1: the deceleration proportion is valid

Rotational speed display=Rotate speed / Rotator speed coefficient setting(F6.11)

FC.7	Reserved	
FC.8	Agency password	Setting range: 0 ~ 9999
FC.9	Reserved	
FC.10	Reserved	
FC.11	Oscillatory inhibiting factor	Setting range: 0.0~ 2.00
FC.12	Reserved	
FC.13	Program version	Range: 1600 ~ 1699

It is read-only parameter.

## 7. FAULT DIAGNOSIS AND COUNTERMEASURES

### 7.1 Protective functions and Countermeasures

Code	Faults	Probable Causes	Solutions
Fu.1	Over-current during Acc	<ol style="list-style-type: none"> <li>1. Acceleration time is too short.</li> <li>2. V/F curve is not suitable</li> <li>3. You hasn't set the right motor parameters</li> <li>4. User start rotating motor, but doesn't set function of detect speed and restart.</li> <li>5. Value of torque boost set too high.</li> <li>6. Power grid voltage is too low</li> </ol>	<ol style="list-style-type: none"> <li>1. Prolong the acceleration time</li> <li>2. Descend the torque boost or adjust the V/F curve</li> <li>3. Input motor's parameter once again and do self-determination to parameter.</li> <li>4. To set function of detecting speed and restart</li> <li>5. To decrease voltage of torque boost</li> <li>6. Check power grid voltage, and reduce power then use</li> </ol>
Fu.2	over-current during Dec	Deceleration time is too short.	Prolong the deceleration time
Fu.3	Over-current during Running or stopping	<ol style="list-style-type: none"> <li>1. Load occurs mutation</li> <li>2. Power grid voltage is too low</li> </ol>	<ol style="list-style-type: none"> <li>1. Decrease load fluctuation</li> <li>2. Check power supply voltage.</li> </ol>
Fu.4	over-voltage during Acc	<ol style="list-style-type: none"> <li>1. Input voltage is too high</li> <li>2. Power supply is switched on or off frequently.</li> </ol>	<ol style="list-style-type: none"> <li>1. Check power supply voltage</li> <li>2. Decrease setting value of F4.11</li> <li>3. Control the on-off of inverter by the control terminal</li> </ol>
Fu.5	over-voltage during Dec	<ol style="list-style-type: none"> <li>1. Deceleration time is too short.</li> <li>2. Input-voltage is abnormal</li> </ol>	<ol style="list-style-type: none"> <li>1. Extend the deceleration time</li> <li>2. Check power supply voltage</li> <li>3. Install or select the brake resistance</li> </ol>
Fu.6	over-voltage during running	<ol style="list-style-type: none"> <li>1. Power supply is abnormal</li> <li>2. There are energy feedback load</li> </ol>	<ol style="list-style-type: none"> <li>1. Check power supply</li> <li>2. Install or select brake resistor</li> </ol>
Fu.7	over-voltage during stop	Power supply is abnormal	Check power supply voltage
Fu.8	Under-voltage during running	<ol style="list-style-type: none"> <li>1. Power supply is abnormal</li> <li>2. There is great fluctuation of load into electric network.</li> </ol>	<ol style="list-style-type: none"> <li>1. Check power supply voltage</li> <li>2. Provide the power supply separately</li> </ol>
Fu.9	protective action of inverterr	<ol style="list-style-type: none"> <li>1. Output is short-circuit or ground</li> <li>2. Load is too heavy</li> </ol>	<ol style="list-style-type: none"> <li>1. Check wiring</li> <li>2. Reduce the load</li> <li>3. Check whether brake resistor is short-circuit</li> </ol>
Fu.10	Output grounding	<ol style="list-style-type: none"> <li>1. The output terminal of inverter grounds</li> <li>2. The wire is too long between inverter and motor and the carrier frequency is too high.</li> </ol>	<ol style="list-style-type: none"> <li>1. Check the connecting wire</li> <li>2. Shorten the connection wire or reduce the carrier frequency.</li> </ol>
Fu.11	Interfere of inverter	Fault action caused by disturbance of electromagnetism	Add absorb circuit around inverter
Fu.12	Inverter over-loading	<ol style="list-style-type: none"> <li>1. Load is too heavy.</li> <li>2. Acceleration time is too short.</li> <li>3. Torque boost is too high or V/F curve is not suitable.</li> <li>4. Voltage of Power supply is too low</li> <li>5. User start rotating motor, but doesn't set function of detecting speed and restart.</li> </ol>	<ol style="list-style-type: none"> <li>1. Reduce the load or replace with higher capacity inverter.</li> <li>2. Prolong Acc time.</li> <li>3. Decrease the torque boost or adjusting V/F curve.</li> <li>4. Check Voltage of Power supply</li> <li>5. To set function of detect speed and restart</li> </ol>
Fu.13	Motor over-loading	<ol style="list-style-type: none"> <li>1. Load is too heavy.</li> <li>2. Acceleration time is too short.</li> <li>3. The setting of protection factor is too small</li> <li>4. Torque boost is too high or V/F curve is not suitable.</li> </ol>	<ol style="list-style-type: none"> <li>1. Reduce the load</li> <li>2. Prolong Acc time</li> <li>3. Increase the over-loading protection factor of motor ( [F4.13] )</li> <li>4. Decrease torque boost voltage and adjust V/F curve.</li> </ol>

Fu.14	Inverter overheat	1. Wind hole is blocked 2. Environmental temperature is too high 3. Fan is damaged	1. Clear air duct or improve the air condition. 2. Improve ventilation condition or decrease carrier frequency. 3. Replace fan.
Fu.15	Reserved		
Fu.16	External equipment failure	There is signal input on the peripheral. Equipment fault input terminal of Inverter	Check the signal source and the pertinent equipments.
Fu.17	Reserved		
Fu.18	Reserved		
Fu.19	Reserved		
Fu.20	Current checking error	1.The current detecting equipment or circuit is damaged 2.Auxiliary power supply has problem	Contract Us
Fu.21	Temperature sensor occur faults	1. Signal line of temperature is poor contact 2. Temperature sensor is damage.	1. Check jack 2. Contract Us
Fu.22- Fu.39	Reserved		
Fu.40	Inner data of storage is wrong.	Read and write errors of the control parameter	Contract Us

## 7.2 Fault record inquiry

AE2series inverter records the last six fault codes and the output parameters of last fault. This information is aid in looking up the fault causes. Fault information and State monitor parameters are stored uniformly, so please refer to the operation way to look up the information.

Monitor Item	Contents	Monitor Item	Contents
d-26	First fault record	d-32	Output frequency of last fault
d-27	Second fault record	d-33	Setting frequency of last fault
d-28	Third fault record	d-34	Output current of last fault
d-29	Fourth fault record	d-35	Output voltage of last fault
d-30	Fifth fault record	d-36	DC voltage of last fault
d-31	Sixth fault record	d-37	Module temperature of last

## 7.3 Reset



- (1) Be sure to check the fault cause and exclude it before reset, otherwise, which may lead to the inverter, permanent damaged.
- (2) If the inverter can not be reset or occur the fault again after reset, please find out the reason. Continuous reset will damage the inverter
- (3) Over-load or over-heat protective action should delay 5 minutes to reset.

When the inverter occurs the fault, you can reset the inverter to resume the normal running by any way as follows:

- I. External reset input-terminal RST and GND terminal are closed, and then off.
- II. While the fault code is displayed, press  key.
- III. It will send fault reset instrument by RS485 interface.
- IV. Turn the power source off.

## 8. MAINTENANCE

As a result of ambient temperature, humidity, dust, vibration and aging of internal components of inverter, the inverter will probably appear the potential problem during running. In order to ensure the inverter to run steadily for a long time, the inverter should be checked up once at 3 to 6 months.



- First of all, turn the inverter's power off. And professional worker performs maintenance.

### 8.1 Daily Maintenance

maintenance points:

Inspection items	Time		Inspection contents	Criterion
	Daily	Periodic		
Running Environment	√		1. Temperature, Humidity 2. Dust, gases	1. When temperature is over 40°C, the panel should be opened. Humidity is less than 90%, and no condensation 2. No peculiar smell, no flammable and explosive gases.
Cooling system		√	1. Installation Environment 2. Fan in inverter	1. Installation environment is well ventilated, and the duct is not blocked. 2. Fan is normal and no abnormal voice.
Inverter	√		1. Vibration, Temperature raise 2. Noises 3. Wire, Terminal	1. Vibration smooth, the temperature of air outlet is normal. 2. Not abnormal voice and no peculiar smell 3. Fastening screw is not loosed.
Motor	√		1. Vibration, Temperature raise 2. Noises	1. Running smooth, and temperature is normal
Input/output Parameters	√		1. Input voltage 2. Output current	1. Input-voltage is in the setup range 2. Output-current is under the rated value

input voltage	Moving-coil voltmeter
Output voltage	Rectifier-type voltmeter
O/I current	Tong-type ammeter



- (1) Inverter has done the electric insulating experiment before leave-factory, so user don't need to do the withstand voltage test.
- (2) Do the insulation test to the inverter if necessary, all of I/O terminals must be connected in short-circuit (R, S, T, L1, L2, U, V, W, P, P-, PB). Strictly prohibit from doing the insulation test for the single terminal. Please use 500V Meg-ohmmeter to perform this test.
- (3) Control circuit can not be used the Meg-ohmmeter to test.
- (4) For insulation test to motor, the connection wire between motor and inverter should be disassembled.



## 8.2 Damageable parts maintenance

Some cells in inverter are worn out or the performance descends in the process of usage process, in order to ensure the stable running of inverter, so the inverter needs to do the preventative maintenance or replace the part if necessary

### (1) Filter capacitor

Pulse current in main circuit will take effect on the performance of aluminum electrolytic filter capacitor, and the degree of effect has relation with the ambient temperature and usage condition. In normal condition, the electrolytic capacitor of inverter should be replaced at 4 to 5 years.

When the electrolytic capacitor leaks out, safety valve falls out or main block of capacitor expands, the corresponding parts should be replaced immediately.

### (2) Cooling fan

The lifetime of all the cooling fans in the inverter is about 15000 hours (that inverter is used continuously about two years). If the fan happens to abnormal noise or vibration, it should be replaced immediately.

## 8.3 Storage

If the inverter don't used for a long time, please notice the following items:

- (1) To avoid storing the inverter at the environment with high-temperature, humidity, vibration or metal dust, and ensure the well ventilation.
- (2) If the inverter is not used for a long time, it should be energized to resume the capability of electrolyte capacitor once at 2 years, at the same time, check the functions of inverter. When the inverter is electrified, its voltage should be increased by an autotransformer step by step and the time should not be less than 5 hours.



If inverter is not used for a long time, the performance of internal filter capacitor will descend.

## 8.4 After sale services

Guarantee time of this inverter is 12 months (From the day of purchase). In guarantee Time, if the inverter occurs fault or be damaged in normal usage, our company will provide the free repair service or replacement.



Guarantee scale is just the master of inverter.

In guarantee time, if the faults are caused by the following cases, certain service cost would be charged.

- ① Malfunction is caused by not following the operation manual or over using the standard specification;
- ② Malfunction is caused by repairing without admission.
- ③ Malfunction is caused by the bad-storage.
- ④ Malfunction is due to application of inverter for abnormal functional needs.
- ⑤ Damage is caused by fire, salt-corrode, gas-corrode, earthquake, storm, flood, lightning strike, voltage abnormal or other force majored.

*Even if over guarantee time, our company will provide the paid service forever.*

## 9. USAGE EXAMPLE

### 9.1 Panel on-off control, Panel potentiometer setting frequency

#### 9.1.1 Parameters setting

1. When F0.4 is 00#0, panel control is valid.
2. When F0.1 is 3, panel potentiometer is valid.

#### 9.1.2 Basic wiring

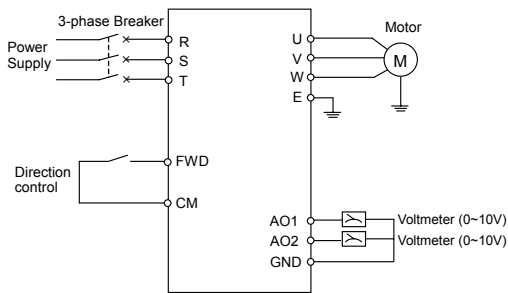

Fig9-1 Basic wiring

#### 9.1.3 Operation Notes:

Press **FWD** key to start the inverter, and then rotate the button of panel potentiometer in clockwise to increase setting frequency step by step. Contrarily, rotate in anti-clockwise to decrease setting frequency step by step.

Press **STOP** key to stop the inverter.



External control terminal FWD decides the running direction of motor.

### 9.2 External on-off control mode, external voltage setting frequency

#### 9.2.1 Initial setting

1. When F0.4 is 00#1, external terminals control is valid.
2. When F0.1 is 5, external voltage VC2 (0~10V) is valid.

#### 9.2.2 Basic wiring

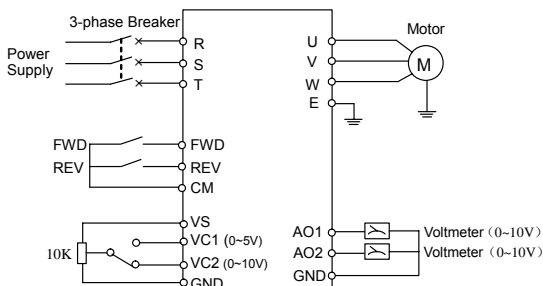

Fig9-2 Basic wiring

### 9.2.3 Operation

FWD-CM is off, the motor will run forward. REV-CM is off, the motor will run backward. FWD-CM and REV-CM are off or on at the same time, the inverter will stop. Setting frequency is set by external voltage signal VC2.



Control method of terminals FWD and REV is set by parameter F0.5.(refer to the explanation about parameter F0.5.)

## 9.3 Multi-speed running, external on-off control mode

### 9.3.1 Initial setting

1. When F0.4 is 00#1, external terminals is valid.
2. To set external terminals X1, X2 and X3 as multi-speed terminals.  
(Namely, parameter [F3.0]~[F3.2])
3. To set running freq. of each stage according to user needs.  
(namely, parameter[F5.1]~[F5.15]).

### 9.3.2 Basic wiring

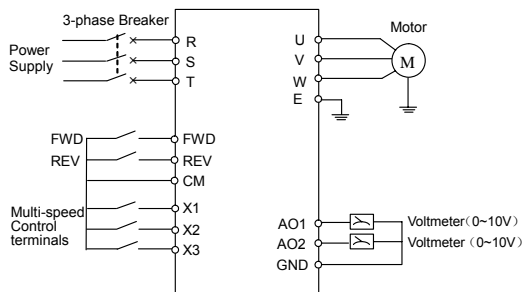

Fig9-3 Basic wiring

### 9.3.3 Operation Notes:

FWD-CM is off, the motor will run forward. REV-CM is off, the motor will run backward. FWD-CM and REV-CM are off or on at the same time, the inverter will stop.

If X1, X2 and X3 are all open with CM, the multi-speed running is invalid. The inverter will run as the setting instruction speed. (The setting frequency channel is selected by parameter F0.1)

If one terminal or all of X1, X2 and X3 are connected with CM terminal, the inverter will run as the multi-speed frequency selected by X1, X2 and X3.

## 9.4 Panel on-off control, Panel potentiometer setting frequency and linkage control with inverters

### 9.4.1 Initial setting

Master setting:

1. Freq. setting channel is panel potentiometer mode. Namely F0.1 is 3.  
Operation channel selection is panel control, namely F0.4 is 00#0.
2. Communication setting (Parameter F9.0) is default.

3. If F9.3 is 0001, the inverter is master.

Slave setting:

1. Freq. setting channel is RS485 interface. Namely F0.1 is 2.
2. Operation channel selection is RS485 interface. Namely F0.4 is 00#2.
3. Communication setting (Parameter F9.0) is default.
4. If F9.3 is 0000, the inverter is slave.
5. Linkage setting proportion (Parameter F9.5) will be set by user needs.
6. Rectify channel of linkage setting proportion is external voltage signal VC1. Namely F9.6 is 2

#### 9.4.2 Basic wiring

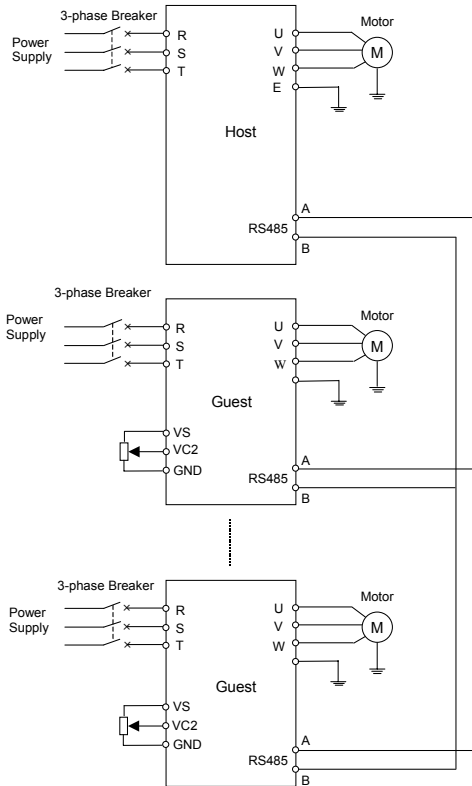

Fig9-4 Basic wiring

#### 9.4.3 Operation Notes:

Running freq. of slave has a certain proportion with master. Linkage setting proportion is set by parameter F9.5.

In this example, freq. proportion of master and slaves can get across by VC1 channel.

## Appendix I RS485 COMMUNICATION PROTOCOL

### 1. Summary

AE2series of inverter provides RS485 interface, users can carry out centralized monitoring through PC/PLC to get operating requirements. The protocol in this appendix is designed for the above functions.

#### 1.1. About protocol

This series communication protocol defines the transmission information and use format in the series communication and it includes master-polling (or broadcasting) format, master coding method and the content includes function code of action, transferring data and error checking. The response of slave is the same structure, and it includes action confirmation, returning the data and error checking etc. If slave takes place the error while it is receiving the information or cannot finish the action demanded by master, it will send one fault signal to master as a response.

#### 1.2. Application scope

##### 1.2.1. Application products

The protocol is fit for all sunfar series of inverters, for example C300, C320, E380 series of inverter, and some other inverters.

##### 1.2.2. Application methods

- (1) The inverter will be connected into a "Single-master Multi-slave " PC/PLC control net with RS485 bus.
- (2) The inverter will be connected into a "Point to Point" PC/PLC monitor background.

### 2. BUS structure and protocol description

#### 2.1. BUS structure

##### (1) Interface mode

There provide RS485 interface and RS232 interface, but RS232 interface need the level translation accessories.

##### (2) Transmission mode

There provide asynchronous series and half-duplex transmission mode. At the same time, just one can send the data and the other only receives the data between master and slave. In the series asynchronous communication, the data is sent out frame by frame in the form of message.

##### (3) Topological mode

In Single-master system, there are 32 sites at most. There are one master site and 31 slave sites among these sites. The address range of slave is 0~30, 31 (1FH) is broadcast communication address. The address of slave must be exclusive in the network. Point to point mode is a special application of single master and multi-slaves mode. That is one condition of one slave machine.

#### 2.2. Protocol description

AE2 series inverter communication protocol is a kind of series master-slave communication protocol, in the network, only one equipment, and master can build a protocol, (Named as "Inquire/Command"). Other equipments, slaves' response "Inquire/Command" of master only by providing the data or doing the action according to the master's "Inquiry/Command". Here, master is Personnel Computer, Industrial Machine or Programmable logical controller, and the slave is inverter. Master not only visits some slave, but also sends the broadcast information to all the slaves. For the single master "Inquiry/Command", all of slaves will return a signal that is a response; for the broadcast information provided by master, slave needs not feedback a response to master machine.

##### 2.2.1. Data format

3 kinds of data transmission format are optional:

- (1) 1 bit start-bit, 8-bit data bits, 1 bit stop-bit and no check bit.
- (2) 1 bit start-bit, 8-bit data bits, 1 bit stop-bit and odd check.

(3) 1 bit start-bit , 8-bit data bits, 1 bit stop bit and even check. It is also manufacture setting.

### 2.2.2. Baud rate

There are five kinds of baud rate, 1200bps, 2400 bps, 4800 bps, 9600 bps and 19200 bps.

### 2.2.3. Communication mode

- (1) Point to point communication mode, which is master "Polling" and slave "Responding".
- (2) Setting the series interface communication parameters by the keypad of inverter. These parameters include local address, baud rate and data format.



Master must set the same baud rate and data format of inverter

### 2.2.4. Communication rule

- (1) There are at least 5-byte startup interval time between data frames, only the message with the stated startup internal time is valid.
- (2) The waiting time of master, with the longest responding time of inverter is 8-byte input time. If not, determined as a failure.
- (3) If inverter doesn't receive any message during setting time of F9.4, it will be occurred the wire-break fault. Running state of slaves is decided by setting value of F9.3.

### 2.3. Message structure

The length of each message is between 11 and 18 bytes. The type of character are ASC II code and hex.

- (1) 3800H is shown as ASC II code.

Data list	9	10	11	12
	Setting Data	Setting Data	Setting Data	Setting Data
Data (ASC II )	33	38	30	30

- (2) 3800H is shown as hex.

Data list	9	10	11	12
	Setting Data	Setting Data	Setting Data	Setting Data
Data (Hex)	0	0	38	00

### 2.3.1 Master command frame

Sending Sequence		Definition	Sending Sequence		Definition
0	Header		9	Setting data	Data area
1	Slave addr.	Slave addr.	10	Setting data	
2	Slave addr		11	Setting data	
3	Type of order	Order area	12	Setting data	
4	Operation order		13	Check sum	Check area
5	Operation order		14	Check sum	
6	Type of data	15	Check sum		
7	Data addr.	Addr. area	16	Check sum	
8	Data addr.		17	Tail	0DH

### 2.3.2 Slave responding frame

Sending Sequence		Definition	Sending Sequence		Definition
0	Header		9	Running data	Data area
1	Slave addr.	Slave addr.	10	Running data	
2	Slave addr		11	Running data	
3	Slave	Responding area	12	Running data	
4	Operation order		13	Check sum	Check area
5	Operation order		14	Check sum	
6	Type of data	Address area	15	Check sum	
7	Data addr.		16	Check sum	
8	Data addr.		17	Tail	0DH

## 2.4. Explanations of data frame of general data

### 2.4.1. Header

This communication protocol defines that both 2AH (ASC II code of character and 5AH are available. When header is 2AH, all of data behind header is ASC II code. When header is 5AH, all of data behind header is hex code and invalid byte fill 0. Unaided headers of 2AH and 5AH aren't rightful header. There need waiting time above five bytes before sending header.

### 2.4.2. Slave address

Slave address is inverter address. The address range of slave machine is 0~30, 31 (1FH) is broadcast communication address.

### 2.4.3. Type of order

Type of order is only in master command frame and defines task of the data in this frame. Length of each frame is different according to different order. Type of order is shown as following table.

Data	Operation
0	Read the state and information of slaves
1	Read the running parameter of slaves
2	Read code parameter
3	Modify code parameter in RAM, it will not save after power down
4	Send control order
5	Modify code parameter in EPROM, it will save after power down
6~F	Reserved

### 2.4.4. Operation order

Master gives a control order to slaves. It exists in all messages and is shown as following table.

Data	Operation	Data	Operation
00H	<b>Invalid instrument</b>	10H	To set running freq. of slave
01H	Start with FWD	11H	Start with FWD and setting freq.
02H	Start with REV	12H	Start with REV and setting freq.
03H	Stop	13H	Stop with Start setting freq.
04H	Slave will FWD running when jog	14H	Slave will FWD running with setting freq. when jog
05H	Slave will REV running when jog	15H	Slave will REV running with setting freq. when jog
06H	Jog running is stop	16H	Slave will JOG running with setting freq.
...	...	...	...
20H	Slave will fault reset	30H	Reserved
21H	Slave will emergency stop	31H	Reserved



➤ When user need not send operation order, please send invalid order 00H.

### 2.4.5. Slave responding

Slave responding exists in all messages and is shown as following table.

Data	Definition	Data	Definition
0	Slave receive data and works well	1	Data received from master is beyond the permission range
2	When slave is running, data can't be modified	3	If modify the data, please input password
4	To try read and write parameter	5	Reserved
6	Appointed code or addr. Is invalid	7	It exist invalid ASC II code in message
8	Type of order or operation order is invalid	9~F	Reserved



- When data of slave responding is 6, 7 or 8, length of responding frame is 11 bytes.

Its frame format is shown as following.

Slave responding	0	1	2	3	4	5	6	7	8	9	10
Header	Slave address	Slave address	Slave responding	0	0	Check Sum	Check Sum	Check Sum	Check sum	Tail	
Definition	Slave address		Order/responding area			Check area				0DH	

### 2.4.6. State feedback

Slave gives a running state about slave to master, and state feedback exists in all messages. It is shown as following table.

Data	Operation	Data	Operation
00H	DC voltage of slave is not ready	10H	Reserved
01H	Slave is FWD running	11H	Accelerating with FWD
02H	Slave is REV running	12H	Accelerating with REV
03H	Slave is stop	13H	Abruptly stop and restart
04H	Slave will FWD running when jog	14H	Decelerating with FED
05H	Slave will REV running when jog	15H	Decelerating with REV
06H	Reserved	16H	Slave is in DC braking state.
...	...	...	...
20H	Slave is in fault state	21H	Slave is emergency



- When slave occurs fault (data of state feedback is 20H), the seventh and eighth of feedback rata frame is fault code.

### 2.4.7. Check sum

The sum of ASC II or hex form slave address to setting data (running data) is check sum.

### 2.4.8. Frame Tail

0DH is hex, namely ASC II of CR is 0DH.



### 3. Description about frame format



➤ When header, tail and check sum in message occur fault form master, slave may be not responding.

(1) Order I is read state and information about slaves

Master Sending	0	1	2	3	4	5	6	7	8	9	10	11	12	13
	Header	Slave addr.	Slave addr.	0	Operation order	Operation order	Data Type	0	0	Check Sum	Check Sum	Check Sum	Check Sum	Tail

Slave responding		Sending Sequence	
0	Header	9	Character information
1	Slave addr.	10	Character information
2	Slave addr	11	Character information
3	Slave responding	12	Character information
4	State feedback	13	Check sum
5	State feedback	14	Check sum
6	Data type	15	Check sum
7	Character information	16	Check sum
8	Character information.	17	Tail

Slave will give different characters information to master according to different data type in master message.

Data Type (master sending)		Character information (slave responding)					
6		7	8	9	10	11	12
0	Read slave inf. about inverter model	Voltage level	0	Power	Power	Power	Power
1	Read slave inf. about inverter series	Reserved	Reserved	Reserved	Reserved	Reserved	Reserved
2	Read slave inf. about program version	Reserved	Reserved	#	#	#	#
3	Read slave inf. about control information	Master control	Setting freq. of master	Reserved	Reserved	Reserved	Reserved
4~F	Reserved	#	#	#	#	#	#

For example, if data type is 0, slave return 400185. 4 means voltage level. 0 means Character information. 0185 means power, 18.5Kw.

(2) Order II is used for reading running parameter of slave

Master Sending	0	1	2	3	4	5	6	7	8	9	10	11	12	13
	Header	Slave addr.	Slave addr.	1	Operation order	Operation order	0	Data subentry	Data subentry	Check Sum	Check Sum	Check Sum	Check Sum	Tail

Slave responding		Sending Sequence	
0	Header	9	Running data
1	Slave addr.	10	Running data
2	Slave addr.	11	Running data
3	Slave responding	12	Running data
Slave responding		Sending Sequence	
4	State feedback	13	Check sum

5	State feedback	14	Check sum
6	0	15	Check sum
7	Data subentry	16	Check sum
8	Data subentry	17	Tail

Data subentry is state monitor parameters, shown as following table.

Monitor item	Data subentry	Returning data form slave
d-0	00	Output frequent
d-1	01	Output current
⋮	⋮	⋮
d-15	15	External pulse input
⋮	⋮	⋮
d-37	37	Temperature of module of last fault



➤ Refer to the explanation about state monitor parameter in the fourth chapter.

(3) Order III is read parameters of code.

Master Sending	0	1	2	3	4	5	6	7	8	9	10	11	12	13
	Header	Subor-dinatio-n addr.	Subor-dinatio-n addr.	2	Operation order	Operation order	Data type	Data Addr.	Data Addr.	Check sum	Check sum	Check sum	Check sum	Tail

Slave responding		Sending Sequence	
0	Header	9	Parameter data
1	Slave addr.	10	Parameter data
2	Slave addr	11	Parameter data
3	Slave responding	12	Parameter data
4	State feedback	13	Check sum
5	State feedback	14	Check sum
6	Data type	15	Check sum
7	Data addr.	16	Check sum
8	Data addr.	17	Tail



➤ Data type and data address are defined in order IV and VI.

(4) order IV is used for modifying parameter of code in RAM.

order VI is used for modifying parameter of code in EPROM.

Master Sending		Sending Sequence	
0	Header	9	Setting data
1	Slave addr.	10	Setting data
2	Slave addr	11	Setting data
3	3 or 5	12	Setting data
4	Operation order	13	Check sum
5	Operation order	14	Check sum
6	Data type	15	Check sum
7	Data addr.	16	Check sum
8	Data addr.	17	Tail

Slave responding		Sending Sequence	
0	Header	9	Setting data
1	Slave addr.	10	Setting data
2	Slave addr	11	Setting data
3	Slave responding	12	Setting data
4	State feedback	13	Check sum
5	State feedback	14	Check sum
6	Data type	15	Check sum
7	Data addr.	16	Check sum
8	Data addr.	17	Tail

Data type is shown as following table.

Parameter unit	F0	F1	F2	F3	F4	F5	F6	F7	F8	F9	FC	FE	FF	FH	FL	FP
Data type	0	1	2	3	4	5	6	7	8	9	A	B	C	D	E	F

For example, data address of F0.8, F1.8 and F#.8 are 8. But data type of them is different.

**Attention: When slaves don't accomplish order form master, setting data is 0000.**

(5) Order V is used for sending control order.

It is fit for routine operation for inverter.

Master Sending		Sending Sequence	
0	Header	8	Setting data
1	Slave addr.	9	Setting data
2	Slave addr	10	Check sum
3	4	11	Check sum
4	Operation order	12	Check sum
5	Operation order	13	Check sum
6	<b>Setting data</b>	14	Tail
7	Setting data		
Slave responding		Sending Sequence	
0	Header	9	Running data
1	Slave addr.	10	Running data
2	Slave addr	11	Running data
3	Slave responding	12	Running data
4	State feedback	13	Check sum
5	State feedback	14	Check sum

6	0	15	Check sum
7	Monitor item	16	Check sum
8	Monitor item	17	Tail

Setting data in master sending is setting freq., which is send form master to slave.

Setting data in slave responding is running parameter, which is send form master. It is set by parameter F6.12.



➤ See the explanation about list of parameter in chapter five

## 4. Usage example

### 4.1. Order I

To read slave model of 0<sup>#</sup>.

master will send:

2A 30 30 30 30 31 30 30 30 30 31 38 31 0D

5A 00 00 00 00 01 00 00 00 00 00 00 01 0D

Slave will respond: (Inverter with 4T0150KW)

2A 30 30 30 30 33 30 32 30 30 30 34 30 32 34 39 0D

5A 00 00 00 00 03 00 02 00 00 00 00 04 00 00 00 09 0D

### 4.2. Order II

To read running parameter of 0<sup>#</sup> slave (namely read d.4, output freq.)

master will send:

2A 30 30 30 30 31 30 34 30 30 31 35 30 30 32 34 42 0D

5A 00 00 00 00 01 00 04 00 00 00 01 50 00 00 00 56 0D

Slave will respond: (Return current DC voltage of generatrix is 285V)

2A 30 30 30 30 31 30 30 30 33 45 37 30 32 36 30 0D

5A 00 00 00 00 01 00 00 00 00 00 03 E7 00 00 00 EB 0D

### 4.3. Order III

To read code parameter of 0<sup>#</sup> slave (namely parameter F0.16)

master will send:

2A 30 30 32 30 31 30 30 31 30 31 38 34 0D

5A 00 00 02 00 01 00 00 01 00 00 00 04 0D

## Appendix II OPTIONS

### 1. Operation panel

Sometimes users need to take operation panel out of the inverter or control cabinet, if users purchase panel base and wire, it is convenient to install and debug. Wire between operation panel and inverter should be less than 15m. If the length is above 15m, long-distance control line is needed.

#### 1.1 Appearance of panel base

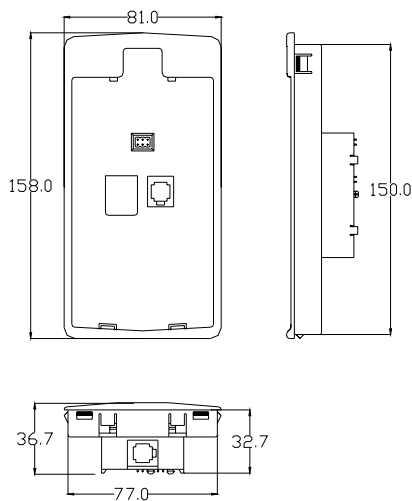

Fig-A Dimension of panel base

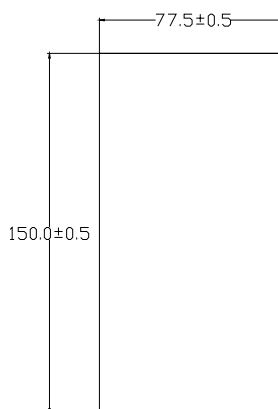

Fig-B Hole dimension of panel base

#### 1.2 Appearance of small panel base

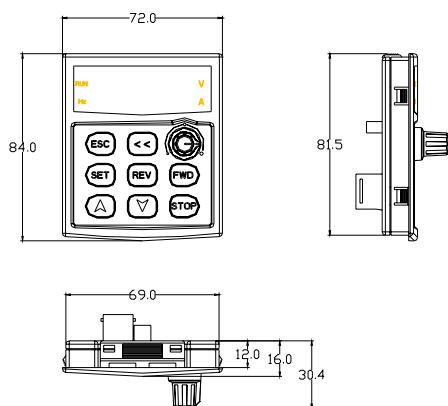

Fig-C Dimension of small panel base

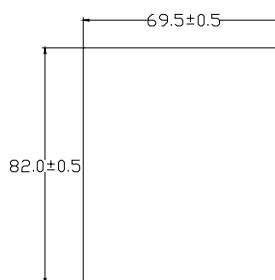

Fig-D Hole dimension of small panel base



It is recommended that users take Fig-B and Fig-D Hole dimension of panel base.

### 1.3 Installation of panel base

Open a hole on the control cabinet according to dimension of panel base. And put the panel horizontally into the hole. Then four locks in panel base will lock. There is an interface on the bottom of base, please insert the long-distance control wire into it.

## 2. Brake resistance

The brake resistance is shown following table.

Model	Applied motor (Kw)	Power of brake resistance (Kw)	Brake resistance ( $\Omega$ )	Brake torque (%)
AE2-2S0015	1.5	0.4	75	100
AE2-2S0022	2.2	0.6	50	100
AE2-2S0037	3.7	1	35	100
AE2-4T0015	1.5	0.5	300	100
AE2-4T0022	2.2	0.65	200	100
AE2-4T0037	3.7	1.0	125	100
AE2-4T0055	5.5	1.5	85	100
AE2-4T0075	7.5	2.0	65	100
AE2-4T0110	11	2.5	50	100
AE2-4T0150	15	3.6	35	100
AE2-4T0185	18.5	4.5	30	100
AE2-4T0220	22	5.5	25	100
AE2-4T0300	30	6.5	20	100
AE2-4T0370	37	8.5	15	100
AE2-4T0450	45	12	12	100
AE2-4T0550	55	15	10	100
AE2-4T0750	75	18	8	100
AE2-4T0900	90	18	8	100
AE2-4T1100	110	25	6	100
AE2-4T1320	132	30	5	100
AE2-4T1600	160	36	4	100
AE2-4T1850	185	42	3.5	100
AE2-4T2000	200	45	3	100
AE2-4T2200	250	50	3	100
AE2-4T2500	250	60	2.5	100
AE2-4T2800	280	60	2.5	100
AE2-4T3150	315	75	2	100
AE2-4T3500	350	75	2	100
AE2-4T4000	400	90	1.5	100

If the braking effect is not obvious, please decrease brake resistance and increase power of brake resistance according to proportion.